

Statewide Space Standards

Version 1.1.7



The State of Missouri
Office of Administration
Division of Facility Management Design and Construction

© 2006

TABLE OF CONTENTS

Publication History	Page 3
Section A - Introduction and Purpose	Page 4
Section B - Job Codes and Space Allocation	Page 5
Section C - Work Space Footprint Standards	Page 26
Section D - Functional Support Area Space Standards	Page 39
Section E - Sample Space Analysis – Under Development	Page 55
Section F - Space Standard Appeals Process	Page 56

Publication History

Issue	Description of Changes	Revision Date	Created By/ Changed By	Requested By
1.1.7	Section B-Changes in Job Codes	4/16/07	Cheryl Kilwin	Sherry Kempf
1.1.6	Section D-Change in Functional Support Area Space Standards; changes in Job Codes	12/26/06	Cheryl Kilwin	Lisa Cavender and Sherry Kempf
1.1.5	Section B-Changes in Job Codes.	10/20/06	Cheryl Kilwin	Sherry Kempf
1.1.4	Section D-Change in Functional Support Area Space Standards.	9/20/06	Cheryl Kilwin	Sherry Kempf
1.1.3	Section B-Changes in Job Codes.	8/11/06	Cheryl Kilwin	Sherry Kempf/Lisa Cavender
1.1.2	Section B-Changes in Job Codes.	8/9/06	Cheryl Kilwin	Sherry Kempf/ Dave Mosby
1.1.1	Section B-Changes in Job Codes.	8/3/06	Cheryl Kilwin	Sherry Kempf
1.1	Section B-Changes in Classification; added Section F-Appeals Process	5/1/06	Cheryl Kilwin	Sherry Kempf
1.0.3	Section B-Changes in Functional Support Area Space Standards	4/20/06	Cheryl Kilwin	Sherry Kempf
1.0.2	Section B-Changes in Classification	4/11/06	Cheryl Kilwin	Sherry Kempf
1.0.1	Section B-Change Index # to Title Code; add Publication History page	4/5/06	Cheryl Kilwin	Kevin Meinhardt

SECTION A – INTRODUCTION AND PURPOSE

State of Missouri

Space Planning Guidelines – Individual Work Space and Functional Support Areas

1. Introduction

Over the past ten years, significant changes have occurred in the office environment. The most important changes are in the technological revolution, work culture (e.g. private offices vs. open plan), staffing trends and occupant expectations. The current space standards for the State of Missouri have not been revised since 1992. The State of Missouri has identified the need to update the Space Planning Guidelines. In beginning this process, other states were interviewed to find out how they are classifying space. Based upon the findings, more and more states are going towards open offices rather than private offices. The revised planning guidelines reflect those discussions and are meant to aid the division and the designer in the support of a functional and effective work environment to accommodate these developments.

2. Purpose

Space Guidelines

The goal of the Space Planning Guidelines is to optimize the utilization of the departmental layout. Work spaces are sized for work performed and for job functions. Open office layouts allow people to work in teams and be near the people with whom they work. By going towards the open plan in the work place, costs are being reduced or eliminated on the teardown and reconstruction. Fast rearrangement of workstations to accommodate organizational changes with a minimum amount of time and expense involved. In addition, large file cabinets should be located outside of cubicles in common file storage areas. Common space and meeting rooms should be used as much as possible to reduce the number of meetings happening in workstations.

SECTION B – JOB CODES AND SPACE ALLOCATION

OFFICE OF ADMINISTRATION DIVISION OF FACILITIES MANAGEMENT JOB DESCRIPTION CODES

TITLE CODE	CLASS TITLE	GRADE	FUNCTIONAL WORK SPACE CODE	WORK SPACE STANDARD	
				PRIVATE/ OPEN	PERSONAL SPACE STANDARD
003005	ACADEMIC TEACHER I	A17	WKSTN-O-0064	O	64
003006	ACADEMIC TEACHER II	A21	WKSTN-O-0064	O	64
003007	ACADEMIC TEACHER III	A23	WKSTN-O-0064	O	64
009780	ACCOUNT CLERK		WKSTN-O-0064	O	64
000301	ACCOUNT CLERK I	A08	WKSTN-O-0048	O	48
000302	ACCOUNT CLERK II	A12	WKSTN-O-0064	O	64
009781	ACCOUNTANT		WKSTN-O-0064	O	64
000311	ACCOUNTANT I	A18	WKSTN-O-0064	O	64
000312	ACCOUNTANT II	A23	WKSTN-O-0064	O	64
000313	ACCOUNTANT III	A26	WKSTN-O-0096	O	96
000352	ACCOUNTING ANALYST I	A21	WKSTN-O-0064	O	64
000353	ACCOUNTING ANALYST II	A24	WKSTN-O-0064	O	64
000354	ACCOUNTING ANALYST III	A28	WKSTN-O-0096	O	96
000355	ACCOUNTING ANALYST IV	A32	WKSTN-O-0120	O	120
000341	ACCOUNTING SPECIALIST I	A22	WKSTN-O-0064	O	64
000342	ACCOUNTING SPECIALIST II	A25	WKSTN-O-0064	O	64
000345	ACCOUNTING SPECIALIST III	A29	WKSTN-O-0096	O	96
009783	ACCOUNTING SUPERVISOR		WKSTN-O-0064	O	64
004418	ACTIVITY AIDE I	A07	WKSTN-O-0064	O	64
004419	ACTIVITY AIDE II	A10	WKSTN-O-0064	O	64
004420	ACTIVITY AIDE III	A13	WKSTN-O-0064	O	64
004421	ACTIVITY THERAPIST	A14	WKSTN-O-0064	O	64
004427	ACTIVITY THERAPY COORINATOR	A30	WKSTN-O-0096	O	96
009779	ACTUARY		WKSTN-O-0064	O	64
000004	ADMINISTRATIVE OFFICE SUPPORT ASSISTANT	A15	WKSTN-O-0064	O	64
000761	ADMINISTRATIVE ANALYST I	A17	WKSTN-O-0064	O	64
000762	ADMINISTRATIVE ANALYST II	A21	WKSTN-O-0064	O	64
000763	ADMINISTRATIVE ANALYST III	A25	WKSTN-O-0064	O	64
009715	ADMINISTRATIVE ASSISTANT		WKSTN-O-0064	O	64
009750	ADMINISTRATIVE SECRETARY		WKSTN-O-0064	O	64
000690	AFFORDABLE HOUSING CONSULTANT (MENTAL HEALTH)	A30	WKSTN-O-0096	O	96
008561	AGENT (LIQUOR CONTROL)	A23	WKSTN-O-0064	O	64
005139	AGING PROGRAM SPECIALIST I	A22	WKSTN-O-0064	O	64
005140	AGING PROGRAM SPECIALIST II	A25	WKSTN-O-0064	O	64
007566	AGRICULTURAL EXPORT FACILITY MANAGER	A22	WKSTN-O-0064	O	64
007570	AGRICULTURAL LOAN OFFICER	A24	WKSTN-O-0064	O	64
007562	AGRICULTURE DEVELOPMENT FUND REPRESENTATIVE	A19	WKSTN-O-0064	O	64
008082	AGRICULTURE MANAGER B1	1	WKSTN-O-0120	O	120
008083	AGRICULTURE MANAGER B2	2	WKSTN-O-0120	O	120
008084	AGRICULTURE MANAGER B3	3	WKSTN-O-0120	O	120
007560	AGRICULTURE MARKET REPORTER	A17	WKSTN-O-0064	O	64
007561	AGRICULTURE PROMOTION SPECIALIST	A21	WKSTN-O-0064	O	64
008515	AIR DEPOT MAINTENANCE SPECIALIST I	A22	WKSTN-O-0064	O	64
008516	AIR DEPOT MAINTENANCE SPECIALIST II	A25	WKSTN-O-0064	O	64
008517	AIR DEPOT MAINTENANCE SPECIALIST III	A28	WKSTN-O-0096	O	96
004656	AIR QUALITY MONITORING SPECIALIST I	A18	WKSTN-O-0064	O	64
004657	AIR QUALITY MONITORING SPECIALIST II	A22	WKSTN-O-0064	O	64
004658	AIR QUALITY MONITORING SPECIALIST III	A25	WKSTN-O-0064	O	64
004659	AIR QUALITY MONITORING SPECIALIST IV	A28	WKSTN-O-0096	O	96
000645	AIRCRAFT MAINTENANCE SPECIALIST	A26	WKSTN-O-0064	O	64
000650	AIRCRAFT PILOT	A31	WKSTN-O-0096	O	96
007546	ANIMAL HEALTH ENFORCEMENT SUPERVISOR	A24	WKSTN-O-0064	O	64
007542	ANIMAL HEALTH INSPECTOR	A15	WKSTN-O-0064	O	64
007545	ANIMAL HEALTH OFFICER	A18	WKSTN-O-0064	O	64

TITLE CODE	CLASS TITLE	GRADE	FUNCTIONAL WORK SPACE CODE	WORK SPACE STANDARD	
				PRIVATE/ OPEN	PERSONAL SPACE STANDARD
007544	ANIMAL HEALTH PROGRAM COORDINATOR	A28	WKSTN-O-0096	O	96
000751	APPEALS REFEREE I	A24	WKSTN-P-0120	P	120* ¹
000752	APPEALS REFEREE II	A27	WKSTN-P-0120	P	120* ¹
000753	APPEALS REFEREE III	A29	WKSTN-P-0120	P	120* ¹
007687	APPRAISAL SPECIALIST	A29	WKSTN-O-0096	O	96
007681	APPRAISER I	A17	WKSTN-O-0064	O	64
007682	APPRAISER II	A22	WKSTN-O-0064	O	64
007683	APPRAISER III	A26	WKSTN-O-0096	O	96
007685	APPRAISER SUPERVISOR	A28	WKSTN-O-0096	O	96
001255	ARCHAEOLOGIST	A24	WKSTN-O-0064	O	64
004735	ARCHITECT I	A28	WKSTN-O-0096	O	96
004736	ARCHITECT II	A30	WKSTN-O-0096	O	96
004737	ARCHITECT III	A33	WKSTN-O-0096	O	96
004470	AREA SUBSTANCE ABUSE TREATMENT COORDINATOR	A28	WKSTN-O-0096	O	96
005161	AREA SUPERVISOR BUSINESS ENTERPRISES FOR BLIND	A22	WKSTN-O-0064	O	64
007780	ARTS COUNCIL PROGRAM SPECIALIST I	A22	WKSTN-O-0064	O	64
007781	ARTS COUNCIL PROGRAM SPECIALIST II	A25	WKSTN-O-0064	O	64
007675	ASSESSMENT REPRESENTATIVE I (TAX COMMISSION)	A18	WKSTN-O-0064	O	64
007676	ASSESSMENT REPRESENTATIVE II (TAX COMMISSION)	A23	WKSTN-O-0064	O	64
007634	ASSISTANT BRANCH OFFICE MANAGER (REVENUE)	A22	WKSTN-O-0048	O	48
000586	ASSISTANT CENTER DIRECTOR (ADMINISTRATION)	A27	WKSTN-O-0096	O	96
000330	ASSISTANT CONTROLLER (MENTAL HEALTH)	A29	WKSTN-O-0096	O	96
008503	ASSISTANT FIRE CHIEF	A27	WKSTN-O-0064	O	64
000239	ASSISTANT FORMS MANAGEMENT MANAGER	A27	WKSTN-O-0096	O	96
009726	ASSISTANT PROGRAM MANAGER		WKSTN-O-0096	O	96
009720	ASSISTANT PROJECT MANAGER		WKSTN-O-0096	O	96
005176	ASSISTANT SUPERVISOR (BUSINESS ENTERPRISES FOR BLIND)	A25	WKSTN-O-0064	O	64
000582	ASSISTANT SUPERVISOR OF VOLUNTEER SERVICES	A13	WKSTN-O-0064	O	64
000325	ASSISTANT TO THE FISCAL OFFICER (MENTAL HEALTH)	A29	WKSTN-O-0096	O	96
005302	ASSISTANT VETERANS HOME ADMINISTRATOR	A28	WKSTN-O-0096	O	96
009722	ASSOCIATE COUNSEL		WKSTN-O-0096	O	96
004401	ASSOCIATE PSYCHOLOGIST II	A25	WKSTN-O-0064	O	64
004104	ASSOCIATE PUBLIC HEALTH LABORATOR SCIENTIST	A19	WKSTN-O-0064	O	64
007860	ATHLETIC INSPECTOR	A18	WKSTN-O-0064	O	64
ZZ0001	ATTORNEY		OFFICE-P-0120	P	120* ¹
009784	AUDITING SUPERVISOR		WKSTN-O-0096	O	96
009782	AUDITOR		WKSTN-O-0064	O	64
000305	AUDITOR I	A21	WKSTN-O-0064	O	64
000304	AUDITOR II	A24	WKSTN-O-0064	O	64
000307	AUDITOR III	A29	WKSTN-O-0096	O	96
006033	AUTOMOTIVE EQUIPMENT OFFICER	A25	WKSTN-O-0064	O	64
002051	BAKER I	A08	WKSTN-O-0048	O	48
002052	BAKER II	A12	WKSTN-O-0064	O	64
002053	BAKER III	A14	WKSTN-O-0064	O	64
006302	BARBER	A11	WKSTN-O-0064	O	64
004384	BEHAVIOR INTERVENTION TECHNICIAN (DEVELOPMENT DISABILITIES)	A13	WKSTN-O-0064	O	64
004510	BEHAVIORAL TECHNICIAN	A12	WKSTN-O-0064	O	64
004511	BEHAVIORAL TECHNICIAN SUPERVISOR	A15	WKSTN-O-0064	O	64
004509	BEHAVIORAL TECHNICIAN TRAINEE	A09	WKSTN-O-0048	O	48
009742	BOARD CHAIRMAN		OFFICE-P-0120	P	120* ¹
009741	BOARD MEMBER		OFFICE-P-0120	P	120* ¹
006101	BOILER OPERATOR	A15	WKSTN-O-0064	O	64
008576	BOILER/PRESSURE VESSEL INSPECTOR	A24	WKSTN-O-0064	O	64
009785	BUDGET & PLANNING ANALYST		WKSTN-O-0064	O	64
000390	BUDGET & PLANNING ANALYST I	A22	WKSTN-O-0064	O	64
000391	BUDGET & PLANNING ANALYST II	A26	WKSTN-O-0096	O	96
000392	BUDGET & PLANNING SENIOR ANALYST	A29	WKSTN-O-0096	O	96
009786	BUDGET & PLANNING SUPERVISOR		WKSTN-O-0096	O	96
000368	BUDGET ANALYST I	A18	WKSTN-O-0064	O	64
000369	BUDGET ANALYST II	A23	WKSTN-O-0064	O	64
000370	BUDGET ANALYST III	A28	WKSTN-O-0096	O	96

Statewide Space Standards

Issue Date: April 16, 2007

Proprietary
Version: 1.1.7
Page 6 of 55

TITLE CODE	CLASS TITLE	GRADE	FUNCTIONAL WORK SPACE CODE	WORK SPACE STANDARD	
				PRIVATE/ OPEN	PERSONAL SPACE STANDARD
000371	BUDGET ANALYST IV	A32	WKSTN-O-0120	O	120
006042	BUILDING CONSTRUCTION SUPERVISOR	A20	WKSTN-O-0064	O	64
006040	BUILDING CONSTRUCTION WORKER I	A16	WKSTN-O-0064	O	64
006041	BUILDING CONSTRUCTION WORKER II	A18	WKSTN-O-0064	O	64
000540	BUILDING MANAGER I	A23	WKSTN-O-0096	O	96
000541	BUILDING MANAGER II	A26	WKSTN-O-0096	O	96
007897	BUSINESS INFORMATION PROGRAM COORDINATOR	A28	WKSTN-O-0096	O	96
007895	BUSINESS INFORMATION SPECIALIST I	A18	WKSTN-O-0064	O	64
007896	BUSINESS INFORMATION SPECIALIST II	A22	WKSTN-O-0064	O	64
000221	BUYER I	A18	WKSTN-O-0064	O	64
000222	BUYER II	A23	WKSTN-O-0064	O	64
000223	BUYER III	A28	WKSTN-O-0096	O	96
000224	BUYER IV	A32	WKSTN-O-0120	O	120
004702	CAPITAL IMPROVEMENTS SPECIALIST I	A25	WKSTN-O-0096	O	96
004703	CAPITAL IMPROVEMENTS SPECIALIST II	A28	WKSTN-O-0096	O	96
004704	CAPITAL IMPROVEMENTS SPECIALIST III	A32	WKSTN-O-0120	O	120
000665	CAPITOL POLICE COMMUNICATIONS OPERATOR	A15	WKSTN-O-0064	O	64
000664	CAPITOL POLICE COMMUNICATIONS SUPERVISOR	A19	WKSTN-O-0064	O	64
000663	CAPITOL POLICE CORPORAL	A22	WKSTN-O-0064	O	64
000662	CAPITOL POLICE LIEUTENANT	A28	WKSTN-O-0120	O	120
000660	CAPITOL POLICE OFFICER	A20	WKSTN-O-0064	O	64
000661	CAPITOL POLICE SERGEANT	A24	WKSTN-O-0096	O	96
006052	CARPENTER	A17	WKSTN-O-0048	O	48
006054	CARPENTER SUPERVISOR	A19	WKSTN-O-0064	O	64
005191	CASE ANALYST	A19	WKSTN-O-0064	O	64
005192	CASE ANALYST SUPERVISOR	A21	WKSTN-O-0096	O	96
004448	CASE MANAGEMENT/ASSESSMENT SUPERVISOR	A25	WKSTN-O-0064	O	64
004445	CASE MANAGER I (DEVELOPMENT DISABILITIES)	A19	WKSTN-O-0064	O	64
004446	CASE MANAGER II (DEVELOPMENT DISABILITIES)	A21	WKSTN-O-0064	O	64
004447	CASE MANAGER III (DEVELOPMENT DISABILITIES)	A23	WKSTN-O-0064	O	64
000359	CENTRAL ACCOUNTING TECHNICIAN	A15	WKSTN-O-0064	O	64
004557	CERTIFICATION CONSULTANT (DEVELOPMENT DISABILITIES)	A32	WKSTN-O-0120	O	120
004001	CERTIFIED DENTAL ASSISTANT	A12	WKSTN-O-0064	O	64
009732	CHAPLAIN		WKSTN-O-0064	O	64
004111	CHEMIST I	A19	WKSTN-O-0064	O	64
004112	CHEMIST II	A22	WKSTN-O-0064	O	64
004113	CHEMIST III	A25	WKSTN-O-0064	O	64
004114	CHEMIST IV	A29	WKSTN-O-0096	O	96
000321	CHIEF ACCOUNTANT	A28	WKSTN-O-0096	O	96
009735	CHIEF COUNSEL		OFFICE-P-0120	P	120* ¹
009737	CHIEF HEARINGS OFFICER		WKSTN-O-0096	O	96
001274	CHIEF PARK RANGER/PROGRAM DIRECTOR	A32	WKSTN-O-0120	O	120
006365	CHIEF PHOTOGRAPHER (TOURISM)	A20	WKSTN-O-0064	O	64
000838	CHIEF PUBLIC UTILITY ACCOUNTANT	A32	WKSTN-O-0120	O	120
000658	CHIEF SECURITY OFFICER	A20	WKSTN-O-0064	O	64
000842	CHIEF UTILITY ECONOMIST	A34	WKSTN-O-0120	O	120
001000	CHILD CARE FACILITY SPECIALIST I	A18	WKSTN-O-0064	O	64
001001	CHILD CARE FACILITY SPECIALIST II	A22	WKSTN-O-0064	O	64
001002	CHILD CARE FACILITY SPECIALIST III	A24	WKSTN-O-0096	O	96
001006	CHILD CARE PROGRAM SPECIALIST	A26	WKSTN-O-0096	O	96
005337	CHILD PLACEMENT COORDINATOR (SOCIAL SERVICES)	A23	WKSTN-O-0064	O	64
005276	CHILD SUPPORT ENFORCEMENT ADMINISTRATOR	A24	WKSTN-O-0096	O	96
005264	CHILD SUPPORT ENFORCEMENT SPECIALIST	A17	WKSTN-O-0064	O	64
005274	CHILD SUPPORT ENFORCEMENT SUPERVISOR	A20	WKSTN-O-0096	O	96
004468	CHILDREN & YOUTH SPECIALIST I (PSYCHIATRIC)	A21	WKSTN-O-0064	O	64
004469	CHILDREN & YOUTH SPECIALIST II (PSYCHIATRIC)	A23	WKSTN-O-0064	O	64
004482	CHILDREN'S PSYCHIATRIC CARE SUPERVISOR	A13	WKSTN-O-0064	O	64
005186	CHILDREN'S SERVICE PROGRAM MANAGER	A24	WKSTN-O-0096	O	96
005201	CHILDREN'S SERVICE SPECIALIST	A23	WKSTN-O-0064	O	64
005184	CHILDREN'S SERVICE SUPERVISOR	A21	WKSTN-O-0096	O	96
005180	CHILDREN'S SERVICE WORKER I	A18	WKSTN-O-0064	O	64
005181	CHILDREN'S SERVICE WORKER II	A20	WKSTN-O-0064	O	64

Statewide Space Standards

Issue Date: April 16, 2007

Proprietary
Version: 1.1.7
Page 7 of 55

TITLE CODE	CLASS TITLE	GRADE	FUNCTIONAL WORK SPACE CODE	WORK SPACE STANDARD	
				PRIVATE/ OPEN	PERSONAL SPACE STANDARD
005153	CHILDREN'S SPECIALIST FOR THE BLIND	A21	WKSTN-O-0064	O	64
004777	CIVIL ENGINEER DAM SAFETY	A32	WKSTN-O-0120	O	120
005260	CLAIMS & RESTITUTION TECHNICIAN I	A16	WKSTN-O-0064	O	64
005261	CLAIMS & RESTITUTION TECHNICIAN II	A19	WKSTN-O-0064	O	64
000719	CLAIMS EXAMINER	A14	WKSTN-O-0064	O	64
000722	CLAIMS SUPERVISOR II	A21	WKSTN-O-0064	O	64
000723	CLAIMS SUPERVISOR III	A24	WKSTN-O-0064	O	64
000781	CLAIMS TECHNICIAN I	A17	WKSTN-O-0064	O	64
000782	CLAIMS TECHNICIAN II	A19	WKSTN-O-0064	O	64
000031	CLERICAL SERVICES SUPERVISOR (FAMILY SERVICES)	A19	WKSTN-O-0064	O	64
009756	CLERICAL SUPERVISOR		WKSTN-O-0064	O	64
009752	CLERK		WKSTN-O-0064	O	64
000001	CLERK I	A06	WKSTN-O-0064	O	64
004301	CLIENT ATTENDANT TRAINEE	A05	WKSTN-O-0048	O	48
009746	CLIENT/PATIENT WORKER		WKSTN-O-0064	O	64
005278	CLINICAL CASEWORK ASSISTANT I	A16	WKSTN-O-0064	O	64
005279	CLINICAL CASEWORK ASSISTANT II	A18	WKSTN-O-0064	O	64
005284	CLINICAL CASEWORK PRACTITIONER I	A21	WKSTN-O-0064	O	64
005285	CLINICAL CASEWORK PRACTITIONER II	A23	WKSTN-O-0064	O	64
004288	CLINICAL DIRECTOR I (PSYCHIATRY)	B13	OFFICE-P-120	P	120* ¹
004289	CLINICAL DIRECTOR II (PSYCHIATRY)	B14	OFFICE-P-120	P	120* ¹
004505	CLINICAL PHARMACIST	A30	WKSTN-O-0096	O	96
005287	CLINICAL SOCIAL WORK COORDINATOR	A28	WKSTN-O-0096	O	96
005280	CLINICAL SOCIAL WORK SPECIALIST	A25	WKSTN-O-0064	O	64
005286	CLINICAL SOCIAL WORK SUPERVISOR	A26	WKSTN-O-0096	O	96
009740	COMMISSION CHAIRMAN		OFFICE-P-0120	P	120* ¹
009739	COMMISSION MEMBER		OFFICE-P-0120	P	120* ¹
ZZ0002	COMMISSIONER		OFFICE-P-0240	P	240* ¹
007325	COMMUNICATIONS SPECIALIST	A18	WKSTN-O-0064	O	64
007337	COMMUNICATIONS WARNING OFFICER	A25	WKSTN-O-0064	O	64
008091	COMMUNITY & ECONOMIC DEVELOPMENT MANAGER B1	1	WKSTN-O-0120	O	120
008092	COMMUNITY & ECONOMIC DEVELOPMENT MANAGER B2	2	WKSTN-O-0120	O	120
008093	COMMUNITY & ECONOMIC DEVELOPMENT MANAGER B3	3	WKSTN-O-0120	O	120
005294	COMMUNITY ASSISTANT	A09	WKSTN-O-0048	O	48
007889	COMMUNITY DEVELOPMENT PROGRAM SPECIALIST	A25	WKSTN-O-0096	O	96
007890	COMMUNITY DEVELOPMENT REPRESENTATIVE I	A18	WKSTN-O-0064	O	64
007891	COMMUNITY DEVELOPMENT REPRESENTATIVE II	A22	WKSTN-O-0064	O	64
007892	COMMUNITY DEVELOPMENT REPRESENTATIVE III	A24	WKSTN-O-0064	O	64
004553	COMMUNITY MENTAL HEALTH SERVICES MANAGER I	A26	WKSTN-O-0096	O	96
004554	COMMUNITY MENTAL HEALTH SERVICES MANAGER II	A28	WKSTN-O-0096	O	96
004552	COMMUNITY MENTAL HEALTH SERVICES SUPERVISOR	A25	WKSTN-O-0096	O	96
004385	COMMUNITY MENTAL HEALTH TECHNICIAN	A11	WKSTN-O-0064	O	64
005259	COMMUNITY SERVICES AIDE	A08	WKSTN-O-0048	O	48
005088	COMMUNITY SERVICES COORDINATOR (YOUTH SERVICES)	A23	WKSTN-O-0064	O	64
000361	COMPLIANCE AUDITOR I	A18	WKSTN-O-0064	O	64
000362	COMPLIANCE AUDITOR II	A21	WKSTN-O-0064	O	64
000363	COMPLIANCE AUDITOR III	A25	WKSTN-O-0064	O	64
000151	COMPUTER INFORMATION TECHNOLOGIST I	A22	WKSTN-O-0064	O	64
000152	COMPUTER INFORMATION TECHNOLOGIST II	A25	WKSTN-O-0064	O	64
000153	COMPUTER INFORMATION TECHNOLOGIST III	A28	WKSTN-O-0096	O	96
000198	COMPUTER INFORMATION TECHNOLOGY MANAGER I	A34	WKSTN-O-0120	O	120
000197	COMPUTER INFORMATION TECHNOLOGY MANAGER II	A35	WKSTN-O-0120	O	120
000165	COMPUTER INFORMATION TECHNOLOGY SPECIALIST I	A30	WKSTN-O-0096	O	96
000166	COMPUTER INFORMATION TECHNOLOGY SPECIALIST II	A33	WKSTN-O-0120	O	120
000167	COMPUTER INFORMATION TECHNOLOGY SPECIALIST III	A34	WKSTN-O-0120	O	120
000157	COMPUTER INFORMATION TECHNOLOGY SUPERVISOR I	A30	WKSTN-O-0096	O	96
000158	COMPUTER INFORMATION TECHNOLOGY SUPERVISOR II	A33	WKSTN-O-0120	O	120
000150	COMPUTER INFORMATION TECHNOLOGY TRAINEE	A18	WKSTN-O-0064	O	64
000136	COMPUTER OPERATIONS SUPERVISOR I	A23	WKSTN-O-0064	O	64
000137	COMPUTER OPERATIONS SUPERVISOR II	A27	WKSTN-O-0096	O	96
009762	COMPUTER OPERATOR		WKSTN-O-0064	O	64
000133	COMPUTER OPERATOR I	A13	WKSTN-O-0064	O	64

Statewide Space Standards

Issue Date: April 16, 2007

Proprietary
Version: 1.1.7
Page 8 of 55

TITLE CODE	CLASS TITLE	GRADE	FUNCTIONAL WORK SPACE CODE	WORK SPACE STANDARD	
				PRIVATE/ OPEN	PERSONAL SPACE STANDARD
000134	COMPUTER OPERATOR II	A17	WKSTN-O-0064	O	64
000135	COMPUTER OPERATOR III	A21	WKSTN-O-0064	O	64
000132	COMPUTER OPERATOR TRAINEE	A09	WKSTN-O-0048	O	48
000124	COMPUTER SUPPORT SERVICES SUPERVISOR	A22	WKSTN-O-0064	O	64
006144	CONSTRUCTION INSPECTOR	A26	WKSTN-O-0096	O	96
006145	CONSTRUCTION INSPECTOR SUPERVISOR	A28	WKSTN-O-0096	O	96
009866	CONSULTING PHYSICIAN		WKSTN-O-0120	O	120
007589	CONSUMER SERVICES BRANCH SUPERVISOR	A23	WKSTN-O-0064	O	64
007588	CONSUMER SERVICES COORDINATOR	A24	WKSTN-O-0064	O	64
007585	CONSUMER SERVICES SPECIALIST I	A18	WKSTN-O-0064	O	64
007586	CONSUMER SERVICES SPECIALIST II	A22	WKSTN-O-0064	O	64
004706	CONTRACT SPECIALIST I (OFFICE OF ADMINISTRATION)	A22	WKSTN-O-0064	O	64
004707	CONTRACT SPECIALIST II (OFFICE OF ADMINISTRATION)	A27	WKSTN-O-0096	O	96
000729	CONTRIBUTIONS DEPUTY	A14	WKSTN-O-0064	O	64
000733	CONTRIBUTIONS SUPERVISOR II	A21	WKSTN-O-0064	O	64
000734	CONTRIBUTIONS SUPERVISOR III	A24	WKSTN-O-0064	O	64
000783	CONTRIBUTIONS TECHNICIAN I	A17	WKSTN-O-0064	O	64
000784	CONTRIBUTIONS TECHNICIAN II	A19	WKSTN-O-0064	O	64
009834	COOK		WKSTN-O-0048	O	48
002061	COOK I	A07	WKSTN-O-0048	O	48
002062	COOK II	A10	WKSTN-O-0048	O	48
002063	COOK III	A15	WKSTN-O-0048	O	48
000989	COORDINATOR OF CHILDRENS PROGRAMS	A26	WKSTN-O-0096	O	96
005169	COORDINATOR PREVENTION OF BLINDNESS	A26	WKSTN-O-0096	O	96
005116	CORRECTIONAL SERVICES TRAINEE (PP/CC)	A18	WKSTN-O-0064	O	64
005092	CORRECTIONS CASEWORKER I	A21	WKSTN-O-0064	O	64
005093	CORRECTIONS CASEWORKER II	A23	WKSTN-O-0064	O	64
005020	CORRECTIONS CLASSIFICATION ASSISTANT	A17	WKSTN-O-0064	O	64
005015	CORRECTIONS IDENTIFICATION OFFICER	A15	WKSTN-O-0064	O	64
005104	CORRECTIONS INVESTIGATOR I	A21	WKSTN-O-0064	O	64
005106	CORRECTIONS LITIGATION COORDINATOR	A21	WKSTN-O-0064	O	64
008100	CORRECTIONS MANAGER B1	1	WKSTN-O-0120	O	120
008101	CORRECTIONS MANAGER B2	2	WKSTN-O-0120	O	120
008102	CORRECTIONS MANAGER B3	3	WKSTN-O-0120	O	120
005001	CORRECTIONS OFFICER I	A16	WKSTN-O-0064	O	64
005002	CORRECTIONS OFFICER II	A18	WKSTN-O-0064	O	64
005003	CORRECTIONS OFFICER III	A20	WKSTN-O-0064	O	64
005016	CORRECTIONS RECORDS OFFICER I	A15	WKSTN-O-0064	O	64
005017	CORRECTIONS RECORDS OFFICER II	A18	WKSTN-O-0064	O	64
005018	CORRECTIONS RECORDS OFFICER III	A22	WKSTN-O-0064	O	64
005005	CORRECTIONS SUPERVISOR I	A23	WKSTN-O-0064	O	64
005006	CORRECTIONS SUPERVISOR II	A27	WKSTN-O-0096	O	96
005035	CORRECTIONS TRAINING OFFICER	A24	WKSTN-O-0064	O	64
005334	CORRESPONDENCE & INFORMATION SPECIALIST I	A21	WKSTN-O-0064	O	64
005335	CORRESPONDENCE & INFORMATION SPECIALIST II	A24	WKSTN-O-0064	O	64
006311	COSMETOLOGIST	A11	WKSTN-O-0064	O	64
009839	COUNSELOR		WKSTN-O-0096	O	96
004439	COUNSELOR IN TRAINING	A20	WKSTN-O-0096	O	96
000089	COURT REPORTER I	A19	WKSTN-O-0064	O	64
000090	COURT REPORTER II	A25	WKSTN-O-0064	O	64
000091	COURT REPORTER SUPERVISOR	A27	WKSTN-O-0096	O	96
001209	CULTURAL RESOURCE PRESERVATIONIST I	A22	WKSTN-O-0064	O	64
001210	CULTURAL RESOURCE PRESERVATIONIST II	A25	WKSTN-O-0064	O	64
001211	CULTURAL RESOURCE PRESERVATIONIST III	A28	WKSTN-O-0096	O	96
002003	CUSTODIAL WORK SUPERVISOR	A10	WKSTN-O-0048	O	48
002001	CUSTODIAL WORKER I	A05	WKSTN-O-0048	O	48
002002	CUSTODIAL WORKER II	A07	WKSTN-O-0048	O	48
000186	DATA BASE ADMINISTRATOR	A34	WKSTN-O-0120	O	120
000187	DATA CENTER MANAGER	A32	WKSTN-O-0120	O	120
000118	DATA CONTROL CLERK I	A08	WKSTN-O-0048	O	48
000119	DATA CONTROL CLERK II	A12	WKSTN-O-0064	O	64
009760	DATA ENTRY OPERATOR		WKSTN-O-0064	O	64

Statewide Space Standards

Issue Date: April 16, 2007

Proprietary
Version: 1.1.7
Page 9 of 55

TITLE CODE	CLASS TITLE	GRADE	FUNCTIONAL WORK SPACE CODE	WORK SPACE STANDARD	
				PRIVATE/ OPEN	PERSONAL SPACE STANDARD
009761	DATA PROCESSOR, CLERICAL		WKSTN-O-0064	O	64
009767	DATA PROCESSOR, CONSULTANT		WKSTN-O-0064	O	64
009766	DATA PROCESSOR, MANAGER		WKSTN-O-0064	O	64
009764	DATA PROCESSOR, PROFESSIONAL		WKSTN-O-0064	O	64
009765	DATA PROCESSOR, SUPERVISOR		WKSTN-O-0064	O	64
009763	DATA PROCESSOR, TECHNICAL		WKSTN-O-0048	O	48
004478	DEAF & HEARING IMPAIRED SERVICES COORDINATOR	A25	WKSTN-O-0064	O	64
004002	DENTAL ASSISTANT	A09	WKSTN-O-0048	O	48
009849	DENTAL CONSULTANT		WKSTN-O-0048	O	48
004003	DENTAL HYGIENIST	A18	WKSTN-O-0064	O	64
009847	DENTIST		WKSTN-O-0120	O	120
004005	DENTIST I	A34	WKSTN-O-0120	O	120
004006	DENTIST II	A36	WKSTN-O-0120	O	120
004007	DENTIST III	A38	WKSTN-O-0120	O	120
ZZ0003	DEPARTMENT DIRECTOR		OFFICE-P-0240	P	240* ¹
ZZ0004	DEPUTY COMMISSIONER		OFFICE-P-0240	P	240* ¹
009749	DEPUTY COUNSEL		OFFICE-P-0120	P	120* ¹
ZZ0005	DEPUTY DIRECTOR		OFFICE-P-0240	P	240* ¹
009706	DEPUTY DIVISION DIRECTOR (EXEMPT DEPUTY, DIVISION LEVEL)		OFFICE-P-0240	P	240* ¹
004292	DEPUTY DIVISION DIRECTOR FOR PSYCHIATRY	B15	OFFICE-P-0120	P	120* ¹
008504	DEPUTY FIRE CHIEF	A28	WKSTN-O-0096	O	96
009702	DEPUTY STATE DEPARTMENT DIRECTOR (EXEMPT DEPUTY, DEPARTMENT LEVEL)		OFFICE-P-0240	P	240* ¹
004723	DESIGN ENGINEER I	A28	WKSTN-O-0096	O	96
004724	DESIGN ENGINEER II	A30	WKSTN-O-0096	O	96
004725	DESIGN ENGINEER III	A34	WKSTN-O-0096	O	96
008001	DESIGN/DEVELOP/SURVEY MANAGER B1	1	WKSTN-O-0120	O	120
008002	DESIGN/DEVELOP/SURVEY MANAGER B2	2	WKSTN-O-0120	O	120
008003	DESIGN/DEVELOP/SURVEY MANAGER B3	3	WKSTN-O-0120	O	120
009703	DESIGNATED PRINCIPAL ASSISTANT, DEPARTMENT LEVEL		OFFICE-P-0120	P	120* ¹
009707	DESIGNATED PRINCIPAL ASSISTANT, DIVISION LEVEL		OFFICE-P-0120	P	120* ¹
004739	DESIGNER I	A22	WKSTN-O-0096	O	96
004740	DESIGNER II	A26	WKSTN-O-0096	O	96
004741	DESIGNER III	A29	WKSTN-O-0096	O	96
004380	DEVELOPMENTAL ASSISTANT I	A07	WKSTN-O-0048	O	48
004381	DEVELOPMENTAL ASSISTANT II	A10	WKSTN-O-0048	O	48
004382	DEVELOPMENTAL ASSISTANT III	A13	WKSTN-O-0048	O	48
002107	DIETARY SERVICES COORDINATOR (MENTAL HEALTH)	A29	WKSTN-O-0096	O	96
002101	DIETITIAN I	A19	WKSTN-O-0064	O	64
002102	DIETITIAN II	A22	WKSTN-O-0064	O	64
002103	DIETITIAN III	A25	WKSTN-O-0064	O	64
002104	DIETITIAN IV	A27	WKSTN-O-0096	O	96
002071	DINING ROOM SUPERVISOR	A10	WKSTN-O-0048	O	48
000866	DISABILITY PROGRAM REPRESENTATIVE	A22	WKSTN-O-0064	O	64
000868	DISABILITY PROGRAM SPECIALIST	A25	WKSTN-O-0064	O	64
007336	DISASTER SECTION MANAGER	A28	WKSTN-O-0096	O	96
001004	DISTRICT CHILD CARE FACILITY SUPERVISOR	A26	WKSTN-O-0096	O	96
008563	DISTRICT SUPERVISOR (LIQUOR CONTROL)	A29	WKSTN-O-0096	O	96
009709	DIVISION BUREAU CHIEF		OFFICE-P-0240	P	240* ¹
ZZ0006	DIVISION COMMISSIONER		OFFICE-P-0240	P	240* ¹
009705	DIVISION DIRECTOR		OFFICE-P-0240	P	240* ¹
009708	DIVISION SECTION DIRECTOR		OFFICE-P-0240	P	240* ¹
009832	DOMESTIC SERVICE CONSULTANT		WKSTN-O-0048	O	48
009831	DOMESTIC SERVICE SUPERVISOR (CUSTODIAL FOOD SERVICE, HOUSE KEEPING)		WKSTN-O-0048	O	48
009830	DOMESTIC SERVICE WORKER (CUSTODIAL FOOD SERVICE, HOUSE KEEPING)		WKSTN-O-0048	O	48
004710	DRAFTER I	A13	WKSTN-O-0064	O	64
004711	DRAFTER II	A18	WKSTN-O-0064	O	64
007900	ECONOMIC DEVELOPMENT INCENTIVE SPECIALIST I	A18	WKSTN-O-0064	O	64
007901	ECONOMIC DEVELOPMENT INCENTIVE SPECIALIST II	A23	WKSTN-O-0064	O	64

Statewide Space Standards

Issue Date: April 16, 2007

Proprietary
Version: 1.1.7
Page 10 of 55

TITLE CODE	CLASS TITLE	GRADE	FUNCTIONAL WORK SPACE CODE	WORK SPACE STANDARD	
				PRIVATE/ OPEN	PERSONAL SPACE STANDARD
007903	ECONOMIC DEVELOPMENT INCENTIVE SPECIALIST III	A27	WKSTN-O-0096	O	96
007790	ECONOMIC DEVELOPMENT INFORMATION & ADVERTISING COORDINATOR	A26	WKSTN-O-0096	O	96
008106	ECONOMIC DEVELOPMENT REGULATORY MANAGER B1	1	WKSTN-O-0120	O	120
008107	ECONOMIC DEVELOPMENT REGULATORY MANAGER B2	2	WKSTN-O-0120	O	120
008108	ECONOMIC DEVELOPMENT REGULATORY MANAGER B3	3	WKSTN-O-0120	O	120
000465	ECONOMIST (OFFICE OF ADMINISTRATION/REVENUE)	A32	WKSTN-O-0120	O	120
000841	ECONOMIST (PUBLIC UTILITY) (NATURAL RESOURCES)	A30	WKSTN-O-0096	O	96
000122	EDP SCHEDULER	A18	WKSTN-O-0064	O	64
003031	EDUCATION ASSISTANT I	A07	WKSTN-O-0048	O	48
003032	EDUCATION ASSISTANT II	A10	WKSTN-O-0048	O	48
003011	EDUCATION SUPERVISOR I	A26	WKSTN-O-0096	O	96
009836	EDUCATIONAL AIDE		WKSTN-O-0048	O	48
009840	EDUCATIONAL SUPERVISOR		WKSTN-O-0096	O	96
006056	ELECTRICIAN	A17	WKSTN-O-0064	O	64
006058	ELECTRICIAN SUPERVISOR	A19	WKSTN-O-0064	O	64
008802	ELECTRONIC GAMING DEVICE COORDINATOR	A26	WKSTN-O-0096	O	96
008801	ELECTRONIC GAMING DEVICE SPECIALIST	A23	WKSTN-O-0064	O	64
006087	ELECTRONICS TECHNICIAN	A18	WKSTN-O-0064	O	64
008716	ELEVATOR SAFETY INSPECTOR	A24	WKSTN-O-0064	O	64
007333	EMERGENCY MANAGEMENT COORDINATOR	A26	WKSTN-O-0096	O	96
007331	EMERGENCY MANAGEMENT OFFICER	A20	WKSTN-O-0064	O	64
007332	EMERGENCY MANAGEMENT SPECIALIST	A24	WKSTN-O-0064	O	64
000980	EMERGENCY MEDICAL SERVICES INSPECTOR I	A22	WKSTN-O-0064	O	64
000981	EMERGENCY MEDICAL SERVICES INSPECTOR II	A25	WKSTN-O-0064	O	64
006116	EMERGENCY PROJECT COORDINATOR	A28	WKSTN-O-0096	O	96
000702	EMPLOYMENT SECURITY DEPUTY	A14	WKSTN-O-0064	O	64
000707	EMPLOYMENT SECURITY SUPERVISOR IV	A27	WKSTN-O-0096	O	96
005205	ENERGY ASSISTANCE TECHNICIAN	A11	WKSTN-O-0048	O	48
004690	ENERGY ENGINEER I	A27	WKSTN-O-0096	O	96
004691	ENERGY ENGINEER II	A30	WKSTN-O-0096	O	96
004626	ENERGY SPECIALIST I	A18	WKSTN-O-0064	O	64
004627	ENERGY SPECIALIST II	A22	WKSTN-O-0064	O	64
004628	ENERGY SPECIALIST III	A25	WKSTN-O-0064	O	64
004629	ENERGY SPECIALIST IV	A28	WKSTN-O-0096	O	96
004760	ENGINEER DAM SAFETY	A29	WKSTN-O-0096	O	96
004643	ENGINEERING CONSULTANT	A33	WKSTN-O-0120	O	120
008119	ENTERPRISES MANAGER B1	1	WKSTN-O-0120	O	120
008120	ENTERPRISES MANAGER B2	2	WKSTN-O-0120	O	120
008121	ENTERPRISES MANAGER B3	3	WKSTN-O-0120	O	120
009857	ENVIRONMENTAL AIDE		WKSTN-O-0048	O	48
000461	ENVIRONMENTAL EDUCATION & INFORMATION SPECIALIST I	A22	WKSTN-O-0064	O	64
000462	ENVIRONMENTAL EDUCATION & INFORMATION SPECIALIST II	A26	WKSTN-O-0096	O	96
004622	ENVIRONMENTAL ENGINEER I	A27	WKSTN-O-0096	O	96
004623	ENVIRONMENTAL ENGINEER II	A29	WKSTN-O-0096	O	96
004624	ENVIRONMENTAL ENGINEER III	A32	WKSTN-O-0096	O	96
004625	ENVIRONMENTAL ENGINEER IV	A35	WKSTN-O-0120	O	120
008010	ENVIRONMENTAL MANAGER B1	1	WKSTN-O-0120	O	120
008011	ENVIRONMENTAL MANAGER B2	2	WKSTN-O-0120	O	120
008012	ENVIRONMENTAL MANAGER B3	3	WKSTN-O-0120	O	120
004612	ENVIRONMENTAL PUBLIC HEALTH SPECIALIST I	A18	WKSTN-O-0064	O	64
004613	ENVIRONMENTAL PUBLIC HEALTH SPECIALIST II	A22	WKSTN-O-0064	O	64
004614	ENVIRONMENTAL PUBLIC HEALTH SPECIALIST III	A25	WKSTN-O-0064	O	64
004615	ENVIRONMENTAL PUBLIC HEALTH SPECIALIST IV	A27	WKSTN-O-0096	O	96
004616	ENVIRONMENTAL PUBLIC HEALTH SPECIALIST V	A28	WKSTN-O-0096	O	96
004618	ENVIRONMENTAL SPECIALIST I	A18	WKSTN-O-0064	O	64
004619	ENVIRONMENTAL SPECIALIST II	A22	WKSTN-O-0064	O	64
004620	ENVIRONMENTAL SPECIALIST III	A25	WKSTN-O-0064	O	64
004621	ENVIRONMENTAL SPECIALIST IV	A28	WKSTN-O-0096	O	96
000930	EPIDEMIOLOGY SPECIALIST	A25	WKSTN-O-0064	O	64
009807	EXECUTIVE (GENERAL ADMINISTRATIVE)		WKSTN-O-0064	O	64
009713	EXECUTIVE DIRECTOR		WKSTN-O-0096	O	96

Statewide Space Standards

Issue Date: April 16, 2007

Proprietary
Version: 1.1.7
Page 11 of 55

TITLE CODE	CLASS TITLE	GRADE	FUNCTIONAL WORK SPACE CODE	WORK SPACE STANDARD	
				PRIVATE/ OPEN	PERSONAL SPACE STANDARD
000501	EXECUTIVE I	A18	WKSTN-O-0064	O	64
000502	EXECUTIVE II	A22	WKSTN-O-0064	O	64
009711	EXECUTIVE SECRETARY		WKSTN-O-0064	O	64
008019	FACILITIES OPERATIONS MANAGER B1	1	WKSTN-O-0120	O	120
008020	FACILITIES OPERATIONS MANAGER B2	2	WKSTN-O-0120	O	120
008021	FACILITIES OPERATIONS MANAGER B3	3	WKSTN-O-0120	O	120
004365	FACILITY ADVISORY NURSE I	A24	WKSTN-O-0064	O	64
004366	FACILITY ADVISORY NURSE II	A28	WKSTN-O-0096	O	64
004368	FACILITY ADVISORY NURSE III	A28	WKSTN-O-0096	O	96
006148	FACILITY ASSESSOR I	A28	WKSTN-O-0096	O	96
006149	FACILITY ASSESSOR II	A30	WKSTN-O-0096	O	96
001010	FACILITY INSPECTOR	A19	WKSTN-O-0064	O	64
007326	FACILITY SURVEY ANALYST	A30	WKSTN-O-0096	O	96
005250	FACILITY SURVEYOR I	A22	WKSTN-O-0064	O	64
005251	FACILITY SURVEYOR II	A25	WKSTN-O-0064	O	64
005252	FACILITY SURVEYOR III	A27	WKSTN-O-0096	O	96
006216	FACTORY MANAGER I	A21	WKSTN-O-0064	O	64
006217	FACTORY MANAGER II	A24	WKSTN-O-0064	O	64
000673	FAMILY SELF-SUFFICIENCY COORDINATOR	A23	WKSTN-O-0064	O	64
005223	FAMILY SUPPORT ELIGIBILITY PROGRAM MANAGER	A24	WKSTN-O-0096	O	96
005202	FAMILY SUPPORT ELIGIBILITY SPECIALIST	A17	WKSTN-O-0064	O	64
005221	FAMILY SUPPORT ELIGIBILITY SUPERVISOR	A21	WKSTN-O-0096	O	96
007521	FEED & SEED INSPECTOR I	A18	WKSTN-O-0064	O	64
007522	FEED & SEED INSPECTOR II	A22	WKSTN-O-0064	O	64
007523	FEED & SEED INSPECTOR III	A24	WKSTN-O-0064	O	64
008810	FINANCIAL AUDITOR	A28	WKSTN-O-0096	O	96
006130	FIRE & SAFETY COORDINATOR	A24	WKSTN-O-0096	O	96
006131	FIRE & SAFETY SPECIALIST	A18	WKSTN-O-0064	O	64
008583	FIRE INSPECTION SUPERVISOR	A27	WKSTN-O-0096	O	96
008581	FIRE INSPECTOR	A22	WKSTN-O-0064	O	64
008573	FIRE INVESTIGATION SUPERVISOR	A29	WKSTN-O-0096	O	96
008571	FIRE INVESTIGATOR	A25	WKSTN-O-0064	O	64
008501	FIREFIGHTER	A19	WKSTN-O-0064	O	64
008502	FIREFIGHTER CREW CHIEF	A24	WKSTN-O-0064	O	64
008028	FISCAL & ADMINISTRATIVE MANAGER B1	1	WKSTN-O-0120	O	120
008029	FISCAL & ADMINISTRATIVE MANAGER B2	2	WKSTN-O-0120	O	120
008030	FISCAL & ADMINISTRATIVE MANAGER B3	3	WKSTN-O-0120	O	120
009788	FISCAL CONSULTANT		WKSTN-O-0064	O	64
009787	FISCAL MANAGER		WKSTN-O-0064	O	64
007345	FLOOD PLAIN MANAGEMENT OFFICER	A28	WKSTN-O-0096	O	96
005306	FOOD PROGRAM REPRESENTATIVE	A22	WKSTN-O-0064	O	64
002073	FOOD SERVICE HELPER I	A05	WKSTN-O-0048	O	48
002074	FOOD SERVICE HELPER II	A07	WKSTN-O-0048	O	48
002066	FOOD SERVICE MANAGER I	A17	WKSTN-O-0064	O	64
002067	FOOD SERVICE MANAGER II	A21	WKSTN-O-0064	O	64
000246	FORMS ANALYST I	A16	WKSTN-O-0064	O	64
000247	FORMS ANALYST II	A20	WKSTN-O-0064	O	64
000248	FORMS ANALYST III	A24	WKSTN-O-0064	O	64
007536	FUEL DEVICE SAFETY INSPECTOR	A19	WKSTN-O-0064	O	64
007539	FUEL DEVICE SAFETY SPECIALIST	A24	WKSTN-O-0064	O	64
005100	FUNCTIONAL UNIT MANAGER (CORRECTIONS)	A24	WKSTN-O-0064	O	64
007864	FUNERAL ESTABLISHMENT INSPECTOR	A24	WKSTN-O-0064	O	64
006034	GARAGE SUPERVISOR	A19	WKSTN-O-0064	O	64
000021	GENERAL OFFICE ASSISTANT	A07	WKSTN-O-0048	O	48
004813	GEOGRAPHIC INFORMATION SYSTEMS ANALYST	A26	WKSTN-O-0096	O	96
004820	GEOGRAPHIC INFORMATION SYSTEMS COORDINATOR	A34	WKSTN-O-0120	O	120
004815	GEOGRAPHIC INFORMATION SYSTEMS SPECIALIST	A30	WKSTN-O-0096	O	96
004810	GEOGRAPHIC INFORMATION SYSTEMS TECHNICIAN I	A18	WKSTN-O-0064	O	64
004811	GEOGRAPHIC INFORMATION SYSTEMS TECHNICIAN II	A22	WKSTN-O-0064	O	64
004762	GEOLOGIST I	A23	WKSTN-O-0064	O	64
004763	GEOLOGIST II	A26	WKSTN-O-0096	O	96
004764	GEOLOGIST III	A28	WKSTN-O-0096	O	96

Statewide Space Standards

Issue Date: April 16, 2007

Proprietary
Version: 1.1.7
Page 12 of 55

TITLE CODE	CLASS TITLE	GRADE	FUNCTIONAL WORK SPACE CODE	WORK SPACE STANDARD	
				PRIVATE/ OPEN	PERSONAL SPACE STANDARD
004765	GEOLOGIST IV	A31	WKSTN-O-0096	O	96
007508	GRAIN INSPECTION COMPLIANCE COORDINATOR	A28	WKSTN-O-0096	O	96
007500	GRAIN INSPECTOR I	A10	WKSTN-O-0048	O	48
007501	GRAIN INSPECTOR II	A15	WKSTN-O-0048	O	48
007502	GRAIN INSPECTOR III	A18	WKSTN-O-0064	O	64
007503	GRAIN INSPECTOR IV	A23	WKSTN-O-0064	O	64
007504	GRAIN INSPECTOR V	A26	WKSTN-O-0096	O	96
007510	GRAIN REGULATORY AUDITOR I	A18	WKSTN-O-0064	O	64
007511	GRAIN REGULATORY AUDITOR II	A21	WKSTN-O-0064	O	64
007512	GRAIN REGULATORY AUDITOR III	A26	WKSTN-O-0096	O	96
007505	GRAIN SAMPLER	A08	WKSTN-O-0048	O	48
006341	GRAPHIC ARTS SPECIALIST I	A12	WKSTN-O-0064	O	64
006342	GRAPHIC ARTS SPECIALIST II	A16	WKSTN-O-0064	O	64
006343	GRAPHIC ARTS SPECIALIST III	A22	WKSTN-O-0064	O	64
006345	GRAPHICS SUPERVISOR	A24	WKSTN-O-0064	O	64
006006	GROUNDSKEEPER I	A10	WKSTN-O-0048	O	48
006007	GROUNDSKEEPER II	A13	WKSTN-O-0048	O	48
003059	GUIDANCE COUNSELOR I	A20	WKSTN-O-0096	O	96
003061	GUIDANCE COUNSELOR II	A23	WKSTN-O-0096	O	96
004410	HABILITATION PROGRAM MANAGER	A25	WKSTN-O-0064	O	64
004407	HABILITATION SPECIALIST I	A17	WKSTN-O-0064	O	64
004408	HABILITATION SPECIALIST II	A21	WKSTN-O-0064	O	64
004409	HABILITATION SUPERVISOR	A23	WKSTN-O-0064	O	64
008174	HEALTH & SENIOR SERVICES MANAGER B1	1	WKSTN-O-0120	O	120
008175	HEALTH & SENIOR SERVICES MANAGER B2	2	WKSTN-O-0120	O	120
008176	HEALTH & SENIOR SERVICES MANAGER B3	3	WKSTN-O-0120	O	120
004330	HEALTH CARE PRACTITIONER (PHYSICIAN ASSISTANT) (NURSE PRACTITIONER)	A32	WKSTN-O-0120	O	120
000945	HEALTH CARE REGULATORY SUPERVISOR	A31	WKSTN-O-0096	O	96
000911	HEALTH EDUCATOR I	A18	WKSTN-O-0064	O	64
000912	HEALTH EDUCATOR II	A22	WKSTN-O-0064	O	64
000913	HEALTH EDUCATOR III	A25	WKSTN-O-0064	O	64
000941	HEALTH FACILITIES CONSULTANT	A28	WKSTN-O-0096	O	96
004356	HEALTH FACILITIES NURSING CONSULTANT	A31	WKSTN-O-0096	O	96
000620	HEALTH INFORMATION ADMINISTRATOR I	A20	WKSTN-O-0064	O	64
000621	HEALTH INFORMATION ADMINISTRATOR II	A25	WKSTN-O-0064	O	64
000618	HEALTH INFORMATION TECHNICIAN I	A15	WKSTN-O-0064	O	64
000619	HEALTH INFORMATION TECHNICIAN II	A17	WKSTN-O-0064	O	64
000592	HEALTH PLANNING SPECIALIST	A24	WKSTN-O-0064	O	64
000574	HEALTH PROGRAM REPRESENTATIVE I	A18	WKSTN-O-0064	O	64
000575	HEALTH PROGRAM REPRESENTATIVE II	A21	WKSTN-O-0064	O	64
000576	HEALTH PROGRAM REPRESENTATIVE III	A24	WKSTN-O-0064	O	64
004550	HEARINGS ADMINISTRATOR (MENTAL HEALTH)	A28	WKSTN-O-0096	O	96
005390	HEARINGS OFFICER	A25	WKSTN-O-0064	O	64
009736	HEARINGS OFFICER		WKSTN-O-0064	O	64
006046	HEAVY EQUIPMENT MECHANIC	A20	WKSTN-O-0064	O	64
006045	HEAVY EQUIPMENT OPERATOR	A17	WKSTN-O-0064	O	64
006047	HEAVY EQUIPMENT SUPERVISOR	A21	WKSTN-O-0064	O	64
005130	HOME & COMMUNITY SERVICES AREA SUPERVISOR	A25	WKSTN-O-0096	O	96
001224	HORTICULTURIST	A21	WKSTN-O-0048	O	48
000510	HOSPITAL MANAGEMENT ASSISTANT	A28	WKSTN-O-0096	O	96
002004	HOUSEKEEPER I	A16	WKSTN-O-0064	O	64
002005	HOUSEKEEPER II	A20	WKSTN-O-0048	O	48
000683	HOUSING DEVELOPMENT APPRAISER	A29	WKSTN-O-0096	O	96
000669	HOUSING DEVELOPMENT OFFICER I	A19	WKSTN-O-0064	O	64
000670	HOUSING DEVELOPMENT OFFICER II	A21	WKSTN-O-0064	O	64
000685	HOUSING PROGRAM AUDITOR & INSPECTOR	A27	WKSTN-O-0096	O	96
000676	HOUSING PROGRAM LOAN ADMINISTRATOR	A27	WKSTN-O-0096	O	96
000407	HUMAN RELATIONS OFFICER I	A24	WKSTN-O-0096	O	96
000408	HUMAN RELATIONS OFFICER II	A26	WKSTN-O-0096	O	96
000409	HUMAN RELATIONS OFFICER III	A28	WKSTN-O-0096	O	96
000406	HUMAN RELATIONS TECHNICIAN	A18	WKSTN-O-0064	O	64

Statewide Space Standards

Issue Date: April 16, 2007

Proprietary
Version: 1.1.7
Page 13 of 55

TITLE CODE	CLASS TITLE	GRADE	FUNCTIONAL WORK SPACE CODE	WORK SPACE STANDARD	
				PRIVATE/ OPEN	PERSONAL SPACE STANDARD
008037	HUMAN RESOURCES MANAGER B1	1	WKSTN-O-0120	O	120
008038	HUMAN RESOURCES MANAGER B2	2	WKSTN-O-0120	O	120
008039	HUMAN RESOURCES MANAGER B3	3	WKSTN-O-0120	O	120
006105	HVAC-INSTRUMENT CONTROLS TECHNICIAN	A18	WKSTN-O-0064	O	64
004793	HYDROLOGIST I	A23	WKSTN-O-0064	O	64
004794	HYDROLOGIST II	A26	WKSTN-O-0096	O	96
004795	HYDROLOGIST III	A28	WKSTN-O-0096	O	96
004796	HYDROLOGIST IV	A31	WKSTN-O-0096	O	96
009798	INFORMATION CONSULTANT		WKSTN-O-0064	O	64
009797	INFORMATION SUPERVISOR		WKSTN-O-0064	O	64
000130	INFORMATION SUPPORT COORDINATOR	A16	WKSTN-O-0064	O	64
009796	INFORMATIONAL WORKER		WKSTN-O-0064	O	64
009747	INMATE WORKER		WKSTN-O-0048	O	48
009820	INSPECTOR		WKSTN-O-0064	O	64
007862	INSPECTOR (PROFESSIONAL REGISTRATION)	A16	WKSTN-O-0064	O	64
007863	INSPECTOR SUPERVISOR (PROFESSIONAL REGISTRATION)	A18	WKSTN-O-0064	O	64
009731	INSTITUTION SUPERINTENDENT		OFFICE-P-0120	P	120* ¹
005029	INSTITUTIONAL ACTIVITY COORDINATOR	A17	WKSTN-O-0064	O	64
009837	INSTRUCTOR		WKSTN-O-0064	O	64
009818	INSURANCE ASSISTANT CHIEF, FINANCIAL/MARKET CONDUCT		WKSTN-O-0096	O	96
009817	INSURANCE AUDIT MANAGER, FINANCIAL/MARKET CONDUCT		WKSTN-O-0064	O	64
009815	INSURANCE EXAMINER, FINANCIAL/MARKET CONDUCT		WKSTN-O-0064	O	64
009816	INSURANCE EXAMINER-IN-CHARGE, FINANCIAL/MARKET CONDUCT		WKSTN-O-0064	O	64
007579	INSURANCE FINANCIAL ANALYSIS SPECIALST	A25	WKSTN-O-0064	O	64
007582	INSURANCE FINANCIAL ANALYST I	A18	WKSTN-O-0064	O	64
007583	INSURANCE FINANCIAL ANALYST II	A23	WKSTN-O-0064	O	64
007593	INSURANCE LICENSING TECHNICIAN I	A10	WKSTN-O-0064	O	64
007594	INSURANCE LICENSING TECHNICIAN II	A13	WKSTN-O-0064	O	64
007575	INSURANCE PRODUCT ANALYST I	A18	WKSTN-O-0064	O	64
007576	INSURANCE PRODUCT ANALYST II	A20	WKSTN-O-0064	O	64
007577	INSURANCE PRODUCT ANALYST III	A22	WKSTN-O-0064	O	64
008128	INSURANCE REGULATORY MANAGER B1	1	WKSTN-O-0120	O	120
008129	INSURANCE REGULATORY MANAGER B2	2	WKSTN-O-0120	O	120
008130	INSURANCE REGULATORY MANAGER B3	3	WKSTN-O-0120	O	120
007581	INSURANCE SURPLUS LINES SPECIALIST	A19	WKSTN-O-0064	O	64
007598	INSURANCE TAX AUDIT SPECIALIST	A23	WKSTN-O-0064	O	64
007563	INTERNATIONAL MARKETING SPECIALIST	A24	WKSTN-O-0064	O	64
004477	INTERPRETER/TRANSLITERATOR	A20	WKSTN-O-0064	O	64
001263	INTERPRETIVE RESOURCE COORDINATOR	A26	WKSTN-O-0096	O	96
001260	INTERPRETIVE RESOURCE SPECIALIST I	A18	WKSTN-O-0064	O	64
001261	INTERPRETIVE RESOURCE SPECIALIST II	A21	WKSTN-O-0064	O	64
001262	INTERPRETIVE RESOURCE SPECIALIST III	A24	WKSTN-O-0064	O	64
001259	INTERPRETIVE RESOURCE TECHNICIAN	A16	WKSTN-O-0064	O	64
008046	INVESTIGATION MANAGER B1	1	WKSTN-O-0120	O	120
008047	INVESTIGATION MANAGER B2	2	WKSTN-O-0120	O	120
008048	INVESTIGATION MANAGER B3	3	WKSTN-O-0120	O	120
005296	INVESTIGATOR I	A18	WKSTN-O-0064	O	64
005297	INVESTIGATOR II	A23	WKSTN-O-0064	O	64
005298	INVESTIGATOR III	A25	WKSTN-O-0064	O	64
009835	JANITOR		WKSTN-O-0048	O	48
005159	JOB DEVELOPMENT SPECIALIST FOR THE BLIND	A23	WKSTN-O-0064	O	64
000792	JOB TRAINING PROGRAM SPECIALIST I	A22	WKSTN-O-0064	O	64
000793	JOB TRAINING PROGRAM SPECIALIST II	A25	WKSTN-O-0064	O	64
008137	LABOR & INDUSTRIAL RELATIONS MANAGER B1	1	WKSTN-O-0120	O	120
008138	LABOR & INDUSTRIAL RELATIONS MANAGER B2	2	WKSTN-O-0120	O	120
008139	LABOR & INDUSTRIAL RELATIONS MANAGER B3	3	WKSTN-O-0120	O	120
000463	LABOR ECONOMIST	A28	WKSTN-O-0096	O	96
009801	LABOR RELATIONS CONSULTANT		WKSTN-O-0064	O	64
006005	LABOR SUPERVISOR	A13	WKSTN-O-0064	O	64
009850	LABORATORY AIDE		WKSTN-O-0048	O	48
004102	LABORATORY ASSISTANT	A06	WKSTN-O-0048	O	48

Statewide Space Standards

Issue Date: April 16, 2007

Proprietary
Version: 1.1.7
Page 14 of 55

TITLE CODE	CLASS TITLE	GRADE	FUNCTIONAL WORK SPACE CODE	WORK SPACE STANDARD	
				PRIVATE/ OPEN	PERSONAL SPACE STANDARD
008055	LABORATORY MANAGER B1	1	WKSTN-O-0120	O	120
008056	LABORATORY MANAGER B2	2	WKSTN-O-0120	O	120
008057	LABORATORY MANAGER B3	3	WKSTN-O-0120	O	120
004170	LABORATORY TECHNICIAN	A09	WKSTN-O-0048	O	48
009851	LABORATORY TECHNICIAN		WKSTN-O-0048	O	48
006001	LABORER I	A06	WKSTN-O-0048	O	48
006002	LABORER II	A09	WKSTN-O-0048	O	48
004754	LAND SURVEY SPECIALIST I	A16	WKSTN-O-0064	O	64
004755	LAND SURVEY SPECIALIST II	A20	WKSTN-O-0064	O	64
004801	LAND SURVEYOR I	A27	WKSTN-O-0096	O	96
004802	LAND SURVEYOR II	A29	WKSTN-O-0096	O	96
004800	LAND SURVEYOR-IN-TRAINING	A25	WKSTN-O-0064	O	64
004774	LANDSCAPE DESIGNER I	A23	WKSTN-O-0096	O	96
004775	LANDSCAPE DESIGNER II	A25	WKSTN-O-0096	O	96
002028	LAUNDRY MANAGER I	A17	WKSTN-O-0064	O	64
002029	LAUNDRY MANAGER II	A21	WKSTN-O-0064	O	64
002026	LAUNDRY SUPERVISOR	A14	WKSTN-O-0064	O	64
002023	LAUNDRY WORKER I	A05	WKSTN-O-0048	O	48
002024	LAUNDRY WORKER II	A07	WKSTN-O-0048	O	48
008064	LAW ENFORCEMENT MANAGER B1	1	WKSTN-O-0120	O	120
008065	LAW ENFORCEMENT MANAGER B2	2	WKSTN-O-0120	O	120
008066	LAW ENFORCEMENT MANAGER B3	3	WKSTN-O-0120	O	120
009734	LEGAL COUNSEL		OFFICE-P-0120	P	120*
000743	LEGISLATIVE COORDINATOR	A29	WKSTN-O-0096	O	96
003020	LIBRARIAN I	A17	WKSTN-O-0064	O	64
003021	LIBRARIAN II	A20	WKSTN-O-0064	O	64
005283	LICENSED CLINICAL SOCIAL WORKER	A24	WKSTN-O-0064	O	64
004317	LICENSED PRACTICAL NURSE I (GENERAL)	A14	WKSTN-O-0064	O	64
004318	LICENSED PRACTICAL NURSE II (GENERAL)	A15	WKSTN-O-0064	O	64
004319	LICENSED PRACTICAL NURSE III (GENERAL)	A18	WKSTN-O-0064	O	64
004440	LICENSED PROFESSIONAL COUNSELOR I	A22	WKSTN-O-0096	O	96
004441	LICENSED PROFESSIONAL COUNSELOR II	A24	WKSTN-O-0096	O	96
000633	LOAN SERVICING OFFICER	A27	WKSTN-O-0096	O	96
006026	LOCKSMITH	A17	WKSTN-O-0064	O	64
005138	LONG-TERM CARE SPECIALIST	A21	WKSTN-O-0064	O	64
008141	LOTTERY MANAGER B1	1	WKSTN-O-0120	O	120
008142	LOTTERY MANAGER B2	2	WKSTN-O-0120	O	120
008143	LOTTERY MANAGER B3	3	WKSTN-O-0120	O	120
007954	LOTTERY SALES COORDINATOR	A24	WKSTN-O-0064	O	64
007952	LOTTERY SALES REPRESENTATIVE	A20	WKSTN-O-0064	O	64
007950	LOTTERY SALES TECHNICIAN	A13	WKSTN-O-0064	O	64
007962	LOTTERY SECURITY SPECIALIST	A28	WKSTN-O-0096	O	96
006060	MACHINIST	A17	WKSTN-O-0064	O	64
000063	MAIL ROOM SUPERVISOR	A18	WKSTN-O-0064	O	64
000060	MAILING EQUIPMENT OPERATOR	A12	WKSTN-O-0064	O	64
006014	MAINTENANCE SUPERVISOR I	A19	WKSTN-O-0064	O	64
006015	MAINTENANCE SUPERVISOR II	A21	WKSTN-O-0064	O	64
006011	MAINTENANCE WORKER I	A13	WKSTN-O-0064	O	64
006012	MAINTENANCE WORKER II	A16	WKSTN-O-0064	O	64
000552	MANAGEMENT ANALYSIS SPECIALIST I	A23	WKSTN-O-0064	O	64
000553	MANAGEMENT ANALYSIS SPECIALIST II	A26	WKSTN-O-0096	O	96
009804	MANAGEMENT ANALYST (GENERAL ADMINISTRATIVE)		WKSTN-O-0064	O	64
00756	MANAGEMENT ANALYST I (EMPLOYMENT SECURITY)	A21	WKSTN-O-0064	O	64
000757	MANAGEMENT ANALYST II (EMPLOYMENT SECURITY)	A24	WKSTN-O-0064	O	64
000758	MANAGEMENT ANALYST III (EMPLOYMENT SECURITY)	A27	WKSTN-O-0096	O	96
009805	MANAGEMENT CONSULTANT (GENERAL ADMINISTRATIVE)		WKSTN-O-0064	O	64
009808	MANAGER (GENERAL ADMINISTRATIVE)		WKSTN-O-0120	O	120
000138	MANAGER OF DATA PROCESSING OPERATIONS	A30	WKSTN-O-0096	O	96
007813	MANAGER, ECONOMIC ANALYSIS	A34	WKSTN-O-0120	O	120
007822	MANAGER, UTILITY POLICY & FEDERAL AFFAIRS	A33	WKSTN-O-0120	O	120
007850	MANUFACTURED HOUSING INSPECTOR I	A18	WKSTN-O-0064	O	64
007849	MANUFACTURED HOUSING INSPECTOR II	A22	WKSTN-O-0064	O	64

Statewide Space Standards

Issue Date: April 16, 2007

Proprietary
Version: 1.1.7
Page 15 of 55

TITLE CODE	CLASS TITLE	GRADE	FUNCTIONAL WORK SPACE CODE	WORK SPACE STANDARD	
				PRIVATE/ OPEN	PERSONAL SPACE STANDARD
007851	MANUFACTURED HOUSING INSPECTOR SUPERVISOR	A24	WKSTN-O-0064	O	64
006051	MARINE MECHANIC	A17	WKSTN-O-0064	O	64
007564	MARKET DEVELOPMENT PROGRAM COORDINATOR	A28	WKSTN-O-0096	O	96
007885	MARKETING SPECIALIST I	A18	WKSTN-O-0064	O	64
007886	MARKETING SPECIALIST II	A24	WKSTN-O-0064	O	64
007887	MARKETING SPECIALIST III	A27	WKSTN-O-0096	O	96
000874	MEDIATOR	A24	WKSTN-O-0064	O	64
005340	MEDICAID CLERK	A15	WKSTN-O-0064	O	64
005338	MEDICAID PHARMACEUTICAL TECHNICIAN	A19	WKSTN-O-0064	O	64
005331	MEDICAID PROGRAM RELATIONS REPRESENTATIVE	A24	WKSTN-O-0064	O	64
005342	MEDICAID SPECIALIST	A23	WKSTN-O-0064	O	64
005341	MEDICAID TECHNICIAN	A19	WKSTN-O-0064	O	64
005344	MEDICAID UNIT SUPERVISOR	A26	WKSTN-O-0096	O	96
009865	MEDICAL ADMINISTRATOR		WKSTN-O-0064	O	64
004282	MEDICAL CONSULTANT	B08	WKSTN-O-0120	O	120
004286	MEDICAL DIRECTOR	B09	OFFICE-P-0120	P	120*
009860	MEDICAL EXTERN		WKSTN-O-0036	O	36
004150	MEDICAL LABORATORY TECHNICIAN I	A09	WKSTN-O-0048	O	48
004151	MEDICAL LABORATORY TECHNICIAN II	A12	WKSTN-O-0064	O	64
004280	MEDICAL SPECIALIST I	B06	WKSTN-O-0120	O	120
004281	MEDICAL SPECIALIST II	B07	WKSTN-O-0120	O	120
004153	MEDICAL TECHNOLOGIST I	A18	WKSTN-O-0064	O	64
004154	MEDICAL TECHNOLOGIST II	A21	WKSTN-O-0064	O	64
004155	MEDICAL TECHNOLOGIST III	A24	WKSTN-O-0064	O	64
004152	MEDICAL TECHNOLOGIST TRAINEE	A15	WKSTN-O-0064	O	64
004507	MENTAL HEALTH COORDINATOR I	A26	WKSTN-O-0096	O	96
004508	MENTAL HEALTH COORDINATOR II	A28	WKSTN-O-0096	O	96
008146	MENTAL HEALTH MANAGER B1	1	WKSTN-O-0120	O	120
008147	MENTAL HEALTH MANAGER B2	2	WKSTN-O-0120	O	120
008148	MENTAL HEALTH MANAGER B3	3	WKSTN-O-0120	O	120
007534	METROLOGY SPECIALIST	A22	WKSTN-O-0064	O	64
008535	MILITARY FUNERAL HONORS AREA COORDINATOR	A18	WKSTN-O-0064	O	64
008537	MILITARY FUNERAL HONORS AREA SUPERVISOR	A22	WKSTN-O-0064	O	64
008539	MILITARY FUNERAL HONORS OPERATIONS COORDINATOR	A22	WKSTN-O-0064	O	64
008533	MILITARY FUNERAL HONORS TEAM LEADER	A15	WKSTN-O-0064	O	64
008531	MILITARY FUNERAL HONORS TEAM MEMBER	A12	WKSTN-O-0064	O	64
008511	MILITARY SECURITY ADMINISTRATOR	A26	WKSTN-O-0096	O	96
008508	MILITARY SECURITY OFFICER I	A17	WKSTN-O-0064	O	64
008509	MILITARY SECURITY OFFICER II	A19	WKSTN-O-0064	O	64
008510	MILITARY SECURITY SUPERVISOR	A22	WKSTN-O-0064	O	64
000895	MINE INSPECTOR	A23	WKSTN-O-0064	O	64
000876	MINE SAFETY INSTRUCTOR	A22	WKSTN-O-0064	O	64
006142	MINORITY CONTRACTS COORDINATOR	A28	WKSTN-O-0096	O	96
000230	MINORITY PURCHASING ASSISTANT	A14	WKSTN-O-0064	O	64
000229	MINORITY/WOMEN CERTIFICATION COORDINATOR	A25	WKSTN-O-0064	O	64
000228	MINORITY/WOMEN PURCHASING COORDINATOR	A28	WKSTN-O-0096	O	96
009813	MISCELLANEOUS ADMINISTRATIVE		WKSTN-O-0064	O	64
009811	MISCELLANEOUS PROFESSIONAL		WKSTN-O-0064	O	64
009812	MISCELLANEOUS SUPERVISORY		WKSTN-O-0096	O	96
009810	MISCELLANEOUS TECHNICAL		WKSTN-O-0048	O	48
005156	MOBILITY SPECIALIST FOR THE BLIND	A23	WKSTN-O-0064	O	64
006021	MOTOR VEHICLE DRIVER	A10	WKSTN-O-0048	O	48
006031	MOTOR VEHICLE MECHANIC	A17	WKSTN-O-0064	O	64
001207	MUSEUM CURATOR	A20	WKSTN-O-0064	O	64
004455	MUSIC THERAPIST I	A19	WKSTN-O-0064	O	64
004456	MUSIC THERAPIST II	A22	WKSTN-O-0064	O	64
004457	MUSIC THERAPIST III	A24	WKSTN-O-0064	O	64
008155	NATURAL RESOURCES MANAGER B1	1	WKSTN-O-0120	O	120
008156	NATURAL RESOURCES MANAGER B2	2	WKSTN-O-0120	O	120
008157	NATURAL RESOURCES MANAGER B3	3	WKSTN-O-0120	O	120
001217	NATURAL RESOURCES STEWARD	A25	WKSTN-O-0064	O	64
004311	NURSING ASSISTANT I	A06	WKSTN-O-0048	O	48

Statewide Space Standards

Issue Date: April 16, 2007

Proprietary
Version: 1.1.7
Page 16 of 55

TITLE CODE	CLASS TITLE	GRADE	FUNCTIONAL WORK SPACE CODE	WORK SPACE STANDARD	
				PRIVATE/ OPEN	PERSONAL SPACE STANDARD
004312	NURSING ASSISTANT II	A09	WKSTN-O-0048	O	48
002114	NUTRITION SPECIALIST	A27	WKSTN-O-0096	O	96
008070	NUTRITION/DIETARY SERVICES MANAGER B1	1	WKSTN-O-0120	O	120
008071	NUTRITION/DIETARY SERVICES MANAGER B2	2	WKSTN-O-0120	O	120
008072	NUTRITION/DIETARY SERVICES MANAGER B3	3	WKSTN-O-0120	O	120
002110	NUTRITIONIST I	A18	WKSTN-O-0064	O	64
002111	NUTRITIONIST II	A22	WKSTN-O-0064	O	64
002112	NUTRITIONIST III	A24	WKSTN-O-0064	O	64
000873	OCCUPATIONAL HEALTH CONSULTANT (WORK COMP)	A27	WKSTN-O-0096	O	96
000777	OCCUPATIONAL RESEARCH ANALYST I	A22	WKSTN-O-0064	O	64
000778	OCCUPATIONAL RESEARCH ANALYST II	A25	WKSTN-O-0064	O	64
000892	OCCUPATIONAL SAFETY & HEALTH CONSULTANT I	A21	WKSTN-O-0064	O	64
000893	OCCUPATIONAL SAFETY & HEALTH CONSULTANT II	A25	WKSTN-O-0064	O	64
000894	OCCUPATIONAL SAFETY & HEALTH CONSULTANT III	A27	WKSTN-O-0096	O	96
000896	OCCUPATIONAL SAFETY & HEALTH SUPERVISOR	A29	WKSTN-O-0096	O	96
004423	OCCUPATIONAL THERAPIST I	A24	WKSTN-O-0064	O	64
004424	OCCUPATIONAL THERAPIST II	A27	WKSTN-O-0096	O	96
004425	OCCUPATIONAL THERAPIST III	A29	WKSTN-O-0096	O	96
004422	OCCUPATIONAL THERAPY ASSISTANT	A16	WKSTN-O-0064	O	64
009717	OFFICE MANAGER		WKSTN-O-0096	O	96
008165	OFFICE OF ADMINISTRATION MANAGER B1	1	WKSTN-O-0120	O	120
008166	OFFICE OF ADMINISTRATION MANAGER B2	2	WKSTN-O-0120	O	120
008167	OFFICE OF ADMINISTRATION MANAGER B3	3	WKSTN-O-0120	O	120
000035	OFFICE SERVICES ASSISTANT	A16	WKSTN-O-0064	O	64
000243	OFFICE SERVICES COORDINATOR I	A26	WKSTN-O-0096	O	96
000002	OFFICE SUPPORT ASSISTANT (CLERICAL)	A08	WKSTN-O-0064	O	64
000022	OFFICE SUPPORT ASSISTANT (KEYBRD)	A09	WKSTN-O-0064	O	64
000012	OFFICE SUPPORT ASSISTANT (STENO)	A10	WKSTN-O-0064	O	64
009755	OFFICE WORKER, MISCELLANEOUS		WKSTN-O-0064	O	64
005032	OUTDOOR REHABILITATION COUNSELOR I	A21	WKSTN-O-0096	O	96
005033	OUTDOOR REHABILITATION COUNSELOR II	A23	WKSTN-O-0096	O	96
009714	OUT-STATE AUDIT PERSONNEL		WKSTN-O-0064	O	64
006066	PAINTER	A17	WKSTN-O-0064	O	64
006068	PAINTER SUPERVISOR	A19	WKSTN-O-0064	O	64
009730	PARALEGAL		WKSTN-O-0096	O	96
006048	PARK MAINTENANCE WORKER I	A10	WKSTN-O-0048	O	48
006049	PARK MAINTENANCE WORKER II	A13	WKSTN-O-0048	O	48
006050	PARK MAINTENANCE WORKER III	A17	WKSTN-O-0064	O	64
001244	PARK OPERATIONS & PLANNING COORDINATOR	A25	WKSTN-O-0064	O	64
001243	PARK OPERATIONS & PLANNING SPECIALIST II	A22	WKSTN-O-0064	O	64
001242	PARK OPERATIONS & PLANNING SPECIALIST I	A18	WKSTN-O-0064	O	64
001270	PARK RANGER	A23	WKSTN-O-0064	O	64
001268	PARK RANGER CORPORAL	A25	WKSTN-O-0064	O	64
001269	PARK RANGER RECRUIT	A21	WKSTN-O-0064	O	64
001271	PARK RANGER SERGEANT	A27	WKSTN-O-0096	O	96
001230	PARK/HISTORIC SITE SPECIALIST I	A18	WKSTN-O-0064	O	64
001231	PARK/HISTORIC SITE SPECIALIST II	A22	WKSTN-O-0064	O	64
001232	PARK/HISTORIC SITE SPECIALIST III	A24	WKSTN-O-0064	O	64
005128	PAROLE HEARING ANALYST	A30	WKSTN-O-0096	O	96
009733	PASTORAL COUNSELOR		WKSTN-O-0096	O	96
009790	PERSONNEL ANALYST		WKSTN-O-0064	O	64
000411	PERSONNEL ANALYST I	A18	WKSTN-O-0064	O	64
000412	PERSONNEL ANALYST II	A23	WKSTN-O-0064	O	64
000413	PERSONNEL ANALYST III	A28	WKSTN-O-0096	O	96
000414	PERSONNEL ANALYST IV	A32	WKSTN-O-0120	O	120
009791	PERSONNEL ANALYST SUPERVISOR		WKSTN-O-0096	O	96
000627	PERSONNEL CLERK	A15	WKSTN-O-0064	O	64
009792	PERSONNEL CONSULTANT		WKSTN-O-0064	O	64
000401	PERSONNEL OFFICER I	A25	WKSTN-O-0064	O	64
000402	PERSONNEL OFFICER II	A28	WKSTN-O-0096	O	96
007516	PESTICIDE USE INVESTIGATOR	A22	WKSTN-O-0064	O	64
004504	PHARMACEUTICAL CONSULTANT	A32	WKSTN-O-0120	O	120

Statewide Space Standards

Issue Date: April 16, 2007

Proprietary
Version: 1.1.7
Page 17 of 55

TITLE CODE	CLASS TITLE	GRADE	FUNCTIONAL WORK SPACE CODE	WORK SPACE STANDARD	
				PRIVATE/ OPEN	PERSONAL SPACE STANDARD
004501	PHARMACIST	A29	WKSTN-O-0096	O	96
004515	PHARMACY ASSISTANT I	A09	WKSTN-O-0064	O	64
004516	PHARMACY ASSISTANT II	A13	WKSTN-O-0064	O	64
004503	PHARMACY DIRECTOR	A34	WKSTN-O-0120	O	120
004502	PHARMACY SUPERVISOR	A32	WKSTN-O-0120	O	120
006363	PHOTOGRAPHER	A15	WKSTN-O-0064	O	64
000067	PHOTOGRAPHIC-MACHINE OPERATOR	A09	WKSTN-O-0048	O	48
004426	PHYSICAL THERAPIST ASSISTANT	A16	WKSTN-O-0064	O	64
004431	PHYSICAL THERAPIST I	A24	WKSTN-O-0064	O	64
004432	PHYSICAL THERAPIST II	A27	WKSTN-O-0096	O	96
004433	PHYSICAL THERAPIST III	A29	WKSTN-O-0096	O	96
004429	PHYSICAL THERAPY AIDE I	A07	WKSTN-O-0048	O	48
004430	PHYSICAL THERAPY AIDE II	A10	WKSTN-O-0048	O	48
004428	PHYSICAL THERAPY TECHNICIAN	A13	WKSTN-O-0064	O	64
004274	PHYSICIAN I	B01	WKSTN-O-0120	O	120
004275	PHYSICIAN II	B03	WKSTN-O-0120	O	120
004276	PHYSICIAN III	B04	WKSTN-O-0120	O	120
000556	PLANNER I	A22	WKSTN-O-0064	O	64
000557	PLANNER II	A25	WKSTN-O-0064	O	64
000558	PLANNER III	A28	WKSTN-O-0096	O	96
000559	PLANNER IV	A32	WKSTN-O-0120	O	120
007529	PLANT INDUSTRIES PROGRAM COORDINATOR	A28	WKSTN-O-0096	O	96
006111	PLANT MAINTENANCE ENGINEER I	A22	WKSTN-O-0064	O	64
006112	PLANT MAINTENANCE ENGINEER II	A24	WKSTN-O-0064	O	64
006113	PLANT MAINTENANCE ENGINEER III	A27	WKSTN-O-0096	O	96
007519	PLANT PROTECTION SPECIALIST	A24	WKSTN-O-0064	O	64
006070	PLUMBER	A17	WKSTN-O-0048	O	48
006072	PLUMBER SUPERVISOR	A19	WKSTN-O-0064	O	64
009868	POLICYMAKING ASSISTANT - DEPARTMENT LEVEL		WKSTN-O-0096	O	96
009869	POLICYMAKING ASSISTANT - DIVISION LEVEL		WKSTN-O-0064	O	64
006074	POWER PLANT MECHANIC	A18	WKSTN-O-0064	O	64
009716	PRINCIPAL ADMINISTRATIVE ASSISTANT		WKSTN-O-0064	O	64
009878	PRINCIPAL ASSISTANT, BOARD/COMMISSION		WKSTN-O-0120	O	120
000098	PRINTING / MAIL COORDINATOR	A22	WKSTN-O-0096	O	96
000097	PRINTING / MAIL CUSTOMER SERVICE REPRESENTATIVE	A20	WKSTN-O-0096	O	96
000093	PRINTING / MAIL TECHNICIAN I	A10	WKSTN-O-0036	O	36*2
000094	PRINTING / MAIL TECHNICIAN II	A13	WKSTN-O-0036	O	36*2
000095	PRINTING / MAIL TECHNICIAN III	A16	WKSTN-O-0036	O	36
000096	PRINTING / MAIL TECHNICIAN IV	A18	WKSTN-O-0064	O	64
000235	PRINTING SERVICES ANALYST	A23	WKSTN-O-0064	O	64
000071	PRINTING SERVICES ASSISTANT	A06	WKSTN-O-0048	O	48
000079	PRINTING SERVICES COORDINATOR	A22	WKSTN-O-0064	O	64
000072	PRINTING SERVICES REPRESENTATIVE	A20	WKSTN-O-0064	O	64
000073	PRINTING SERVICES TECHNICIAN I	A10	WKSTN-O-0048	O	48
000074	PRINTING SERVICES TECHNICIAN II	A13	WKSTN-O-0064	O	64
000075	PRINTING SERVICES TECHNICIAN III	A16	WKSTN-O-0064	O	64
000076	PRINTING SERVICES TECHNICIAN IV	A18	WKSTN-O-0064	O	64
005118	PROBATION & PAROLE ASSISTANT I	A16	WKSTN-O-0064	O	64
005119	PROBATION & PAROLE ASSISTANT II	A18	WKSTN-O-0064	O	64
005117	PROBATION & PAROLE OFFICER I	A18	WKSTN-O-0096	O	96
005121	PROBATION & PAROLE OFFICER II	A21-P	WKSTN-O-0096	O	96
005122	PROBATION & PAROLE OFFICER III	A23-P	WKSTN-O-0096	O	96
005120	PROBATION & PAROLE UNIT SUPERVISOR	A26	WKSTN-P-0120	P	120*1
000236	PROCUREMENT OFFICER I	A23	WKSTN-O-0064	O	64
000237	PROCUREMENT OFFICER II	A28	WKSTN-O-0096	O	96
006281	PRODUCTION SPECIALIST I (CORRECTIONS)	A25	WKSTN-O-0064	O	64
006282	PRODUCTION SPECIALIST II (CORRECTIONS)	A27	WKSTN-O-0096	O	96
007870	PROFESSIONAL REGISTRATION ADMINISTRATIVE COORDINATOR	A24	WKSTN-O-0064	O	64
007867	PROFESSIONAL REGISTRATION LICENSING TECHNICIAN I	A12	WKSTN-O-0064	O	64
007868	PROFESSIONAL REGISTRATION LICENSING TECHNICIAN II	A14	WKSTN-O-0064	O	64
007869	PROFESSIONAL REGISTRATION LICENSING/CERTIFICATION	A18	WKSTN-O-0064	O	64

Statewide Space Standards

Issue Date: April 16, 2007

Proprietary
Version: 1.1.7
Page 18 of 55

TITLE CODE	CLASS TITLE	GRADE	FUNCTIONAL WORK SPACE CODE	WORK SPACE STANDARD	
				PRIVATE/ OPEN	PERSONAL SPACE STANDARD
	SUPERVISOR				
007880	PROFESSIONAL REGISTRATION OPERATIONS COORDINATOR	A23	WKSTN-O-0064	O	64
009728	PROGRAM CONSULTANT		WKSTN-O-0064	O	64
004541	PROGRAM COORDINATOR (MENTAL HEALTH) (HEALTH & SENIOR SERVICES)	A30	WKSTN-O-0096	O	96
005249	PROGRAM DEVELOPMENT SPECIALIST	A25	WKSTN-O-0064	O	64
009725	PROGRAM MANAGER		WKSTN-O-0096	O	96
009729	PROGRAM SPECIALIST		WKSTN-O-0064	O	64
004544	PROGRAM SPECIALIST I (MENTAL HEALTH/REHAB SERVICES)	A24	WKSTN-O-0096	O	96
004539	PROGRAM SPECIALIST II (MENTAL HEALTH/REHAB SERVICES)	A26	WKSTN-O-0096	O	96
009727	PROGRAM SUPERVISOR		WKSTN-O-0096	O	96
009723	PROJECT CONSULTANT		WKSTN-O-0064	O	64
009719	PROJECT MANAGER		WKSTN-O-0096	O	96
009724	PROJECT SPECIALIST		WKSTN-O-0064	O	64
009721	PROJECT SUPERVISOR		WKSTN-O-0096	O	96
009771	PROPERTY ASSISTANT		WKSTN-O-0064	O	64
000217	PROPERTY CONTROL ASSISTANT	A16	WKSTN-O-0064	O	64
004307	PSYCHIATRIC AIDE I	A07	WKSTN-O-0048	O	48
004308	PSYCHIATRIC AIDE II	A10	WKSTN-O-0048	O	48
004277	PSYCHIATRIST I	B10	WKSTN-O-0120	O	120
004278	PSYCHIATRIST II	B11	WKSTN-O-0120	O	120
004402	PSYCHOLOGIST I	A29	WKSTN-O-0096	O	96
004403	PSYCHOLOGIST II	A31	WKSTN-O-0096	O	96
004376	PUBLIC HEALTH CONSULTANT NURSE	A31	WKSTN-O-0096	O	96
000933	PUBLIC HEALTH EPIDEMIOLOGIST	A32	WKSTN-O-0120	O	120
004105	PUBLIC HEALTH LABORATORY SCIENTIST	A23	WKSTN-O-0064	O	64
004372	PUBLIC HEALTH NURSE	A26	WKSTN-O-0064	O	64
004374	PUBLIC HEALTH SENIOR NURSE	A29	WKSTN-O-0096	O	96
007556	PUBLIC INFORMATION & MARKETING COORDINATOR (STATE FAIR)	A28	WKSTN-O-0096	O	96
000458	PUBLIC INFORMATION ADMINISTRATOR	A28	WKSTN-O-0096	O	96
000454	PUBLIC INFORMATION COORDINATOR	A24	WKSTN-O-0064	O	64
000451	PUBLIC INFORMATION SPECIALIST I	A18	WKSTN-O-0064	O	64
000452	PUBLIC INFORMATION SPECIALIST II	A21	WKSTN-O-0064	O	64
008183	PUBLIC SAFETY MANAGER B1	1	WKSTN-O-0120	O	120
008184	PUBLIC SAFETY MANAGER B2	2	WKSTN-O-0120	O	120
008185	PUBLIC SAFETY MANAGER B3	3	WKSTN-O-0120	O	120
008551	PUBLIC SAFETY PROGRAM REPRESENTATIVE I	A18	WKSTN-O-0064	O	64
008552	PUBLIC SAFETY PROGRAM REPRESENTATIVE II	A22	WKSTN-O-0064	O	64
008553	PUBLIC SAFETY PROGRAM SPECIALIST	A25	WKSTN-O-0064	O	64
000836	PUBLIC UTILITY ACCOUNTANT I	A21	WKSTN-O-0064	O	64
000837	PUBLIC UTILITY ACCOUNTANT II	A24	WKSTN-O-0064	O	64
000839	PUBLIC UTILITY ACCOUNTANT III	A26	WKSTN-O-0096	O	96
000845	PUBLIC UTILITY ENGINEER	A34	WKSTN-O-0120	O	120
000848	PUBLIC UTILITY FINANCIAL ANALYST	A25	WKSTN-O-0064	O	64
009774	PURCHASING OFFICER		WKSTN-O-0064	O	64
004597	QUALITY ASSURANCE SPECIALIST (MENTAL HEALTH)	A25	WKSTN-O-0064	O	64
006089	RADIO TECHNICIAN	A24	WKSTN-O-0064	O	64
007222	RADIO/TELECOMMUNICATIONS COORDINATOR	A22	WKSTN-O-0064	O	64
007220	RADIO/TELECOMMUNICATIONS OFFICER	A18	WKSTN-O-0064	O	64
007221	RADIO/TELECOMMUNICATIONS SUPERVISOR	A20	WKSTN-O-0064	O	64
007324	RADIOLOGICAL DEFENSE OFFICER	A28	WKSTN-O-0096	O	96
007335	RADIOLOGICAL EMERGENCY PLANNER	A27	WKSTN-O-0096	O	96
007323	RADIOLOGICAL SYSTEMS MAINTENANCE SUPERVISOR	A23	WKSTN-O-0064	O	64
007322	RADIOLOGICAL SYSTEMS MAINTENANCE TECHNICIAN	A18	WKSTN-O-0064	O	64
007843	RATE & TARIFF EXAMINATION SUPERVISOR	A32	WKSTN-O-0120	O	120
007840	RATE & TARIFF EXAMINER I	A22	WKSTN-O-0064	O	64
007841	RATE & TARIFF EXAMINER II	A25	WKSTN-O-0064	O	64
007842	RATE & TARIFF EXAMINER III	A28	WKSTN-O-0096	O	96
007875	REAL ESTATE EDUCATION SPECIALIST	A18	WKSTN-O-0064	O	64
007871	REAL ESTATE EXAMINER I	A18	WKSTN-O-0064	O	64
007872	REAL ESTATE EXAMINER II	A23	WKSTN-O-0064	O	64

Statewide Space Standards

Issue Date: April 16, 2007

Proprietary
Version: 1.1.7
Page 19 of 55

TITLE CODE	CLASS TITLE	GRADE	FUNCTIONAL WORK SPACE CODE	WORK SPACE STANDARD	
				PRIVATE/ OPEN	PERSONAL SPACE STANDARD
007873	REAL ESTATE EXAMINER SUPERVISOR	A26	WKSTN-O-0096	O	96
009757	RECEPTIONIST		WKSTN-O-0064	O	64
005026	RECREATION OFFICER I	A17	WKSTN-O-0064	O	64
005027	RECREATION OFFICER II	A19	WKSTN-O-0064	O	64
005028	RECREATION OFFICER III	A23	WKSTN-O-0064	O	64
004463	RECREATIONAL THERAPIST I	A19	WKSTN-O-0064	O	64
004464	RECREATIONAL THERAPIST II	A22	WKSTN-O-0064	O	64
004465	RECREATIONAL THERAPIST III	A24	WKSTN-O-0064	O	64
006035	REFRIGERATION MECHANIC I	A18	WKSTN-O-0064	O	64
006036	REFRIGERATION MECHANIC II	A20	WKSTN-O-0064	O	64
005233	REGIONAL CONSULTANT-RESIDENTIAL LICENSING UNIT	A26	WKSTN-O-0096	O	96
005082	REGIONAL FAMILY SPECIALIST	A23	WKSTN-O-0064	O	64
160695	REGIONAL MANAGER - BROADBAND I	A28	OFFICE-P-120	P	120* ¹
004590	REGIONAL PROGRAM SPECIALIST (DEVELOP DISABIL)	A26	WKSTN-O-0096	O	96
004320	REGISTERED NURSE I	A22	WKSTN-O-0064	O	64
004321	REGISTERED NURSE II	A24	WKSTN-O-0064	O	64
004322	REGISTERED NURSE III	A27	WKSTN-O-0064	O	64
004323	REGISTERED NURSE IV	A29	WKSTN-O-0096	O	96
004324	REGISTERED NURSE V	A30	WKSTN-O-0096	O	96
004325	REGISTERED NURSE VI	A32	WKSTN-O-0096	O	96
004326	REGISTERED NURSE VII	A34	WKSTN-O-0120	O	120
007810	REGULATORY ECONOMIST I	A25	WKSTN-O-0064	O	64
007811	REGULATORY ECONOMIST II	A28	WKSTN-O-0096	O	96
007812	REGULATORY ECONOMIST III	A32	WKSTN-O-0120	O	120
009738	REGULATORY LAW JUDGE		OFFICE-P-0120	P	120* ¹
005165	REHABILITATION ASSISTANT (REHAB SRVS FOR THE BLIND)	A13	WKSTN-O-0064	O	64
005167	REHABILITATION COUNSELOR FOR THE BLIND II	A22	WKSTN-O-0096	O	96
005151	REHABILITATION TEACHER FOR THE BLIND	A21	WKSTN-O-0064	O	64
000623	REIMBURSEMENT OFFICER I	A17	WKSTN-O-0064	O	64
000624	REIMBURSEMENT OFFICER II	A20	WKSTN-O-0064	O	64
000625	REIMBURSEMENT OFFICER III	A22	WKSTN-O-0064	O	64
000431	RESEARCH ANALYST I	A18	WKSTN-O-0064	O	64
000432	RESEARCH ANALYST II	A22	WKSTN-O-0064	O	64
000433	RESEARCH ANALYST III	A25	WKSTN-O-0064	O	64
000434	RESEARCH ANALYST IV	A28	WKSTN-O-0096	O	96
009795	RESEARCH CONSULTANT		WKSTN-O-0064	O	64
008073	RESEARCH MANAGER B1	1	WKSTN-O-0120	O	120
008074	RESEARCH MANAGER B2	2	WKSTN-O-0120	O	120
008075	RESEARCH MANAGER B3	3	WKSTN-O-0120	O	120
009793	RESEARCH WORKER		WKSTN-O-0064	O	64
009862	RESIDENT PHYSICIAN		WKSTN-O-0120	O	120
007627	REVENUE FIELD SERVICES COORDINATOR	A22	WKSTN-O-0064	O	64
007626	REVENUE FIELD SERVICES REPRESENTATIVE	A19	WKSTN-O-0064	O	64
007631	REVENUE LICENSING TECHNICIAN I	A10	WKSTN-O-0048	O	48
007632	REVENUE LICENSING TECHNICIAN II	A13	WKSTN-O-0048	O	48
007615	REVENUE LICENSING UNIT SUPERVISOR	A16	WKSTN-O-0064	O	64
008192	REVENUE MANAGER B1	1	WKSTN-O-0120	O	120
008193	REVENUE MANAGER B2	2	WKSTN-O-0120	O	120
008194	REVENUE MANAGER B3	3	WKSTN-O-0120	O	120
007616	REVENUE SECTION SUPERVISOR	A22	WKSTN-O-0096	O	96
000520	RISK MANAGEMENT SPECIALIST I	A25	WKSTN-O-0064	O	64
000523	RISK MANAGEMENT SPECIALIST II	A28	WKSTN-O-0096	O	96
000518	RISK MANAGEMENT TECHNICIAN I	A14	WKSTN-O-0064	O	64
000519	RISK MANAGEMENT TECHNICIAN II	A18	WKSTN-O-0064	O	64
006380	SATELLITE BROADCAST & VIDEO PRODUCER	A26	WKSTN-O-0096	O	96
009833	SEAMSTRESS		WKSTN-O-0048	O	48
009823	SEASONAL AIDE		WKSTN-O-0048	O	48
009824	SEASONAL NATURALIST		WKSTN-O-0064	O	64
009751	SECRETARY		WKSTN-O-0064	O	64
000190	SECTION MANAGER (DIVISION OF INFORMATION SERVICES)	A35	WKSTN-O-0120	O	120
004303	SECURITY AIDE I (PSYCHIATRIC)	A16	WKSTN-O-0064	O	64
004304	SECURITY AIDE II (PSYCHIATRIC)	A18	WKSTN-O-0064	O	64

Statewide Space Standards

Issue Date: April 16, 2007

Proprietary
Version: 1.1.7
Page 20 of 55

TITLE CODE	CLASS TITLE	GRADE	FUNCTIONAL WORK SPACE CODE	WORK SPACE STANDARD	
				PRIVATE/ OPEN	PERSONAL SPACE STANDARD
004305	SECURITY AIDE III (PSYCHIATRIC)	A21	WKSTN-O-0064	O	64
004302	SECURITY ATTENDANT	A15	WKSTN-O-0064	O	64
002042	SECURITY GUARD	A08	WKSTN-O-0048	O	48
000655	SECURITY OFFICER I	A12	WKSTN-O-0064	O	64
000656	SECURITY OFFICER II	A14	WKSTN-O-0064	O	64
000657	SECURITY OFFICER III	A16	WKSTN-O-0064	O	64
007496	SEED ANALYST I	A12	WKSTN-O-0064	O	64
007497	SEED ANALYST II	A17	WKSTN-O-0064	O	64
007498	SEED ANALYST III	A20	WKSTN-O-0064	O	64
007495	SEED ANALYST TRAINEE	A08	WKSTN-O-0048	O	48
005206	SELF-SUFFICIENCY CASE MANAGER	A19	WKSTN-O-0064	O	64
000306	SENIOR AUDITOR	A26	WKSTN-O-0096	O	96
009748	SENIOR COUNSEL		OFFICE-P-0120	P	120* ¹
000931	SENIOR EPIDEMIOLOGY SPECIALIST	A28	WKSTN-O-0096	O	96
000671	SENIOR HOUSING DEVELOPMENT OFFICER	A23	WKSTN-O-0064	O	64
000686	SENIOR HOUSING PROGRAM AUDITOR & INSPECTOR	A29	WKSTN-O-0096	O	96
000003	SENIOR OFFICE SUPPORT ASSISTANT (CLERICAL)	A12	WKSTN-O-0064	O	64
000023	SENIOR OFFICE SUPPORT ASSISTANT (KEYBRD)	A12	WKSTN-O-0064	O	64
000013	SENIOR OFFICE SUPPORT ASSISTANT (STENO)	A13	WKSTN-O-0064	O	64
004279	SENIOR PSYCHIATRIST	B12	WKSTN-O-0120	O	120
004106	SENIOR PUBLIC HEALTH LABORATORY SCIENTIST	A26	WKSTN-O-0096	O	96
005173	SENIOR VOCATIONAL REHABILITATION COUNSELOR FOR THE BLIND	A24	WKSTN-O-0120	O	120
005085	SERVICE COORDINATION SUPERVISOR (YOUTH SERVICES)	A25	WKSTN-O-0096	O	96
005083	SERVICE COORDINATOR (YOUTH SERVICES)	A20	WKSTN-O-0064	O	64
005084	SERVICE COORDINATOR II (YOUTH SERVICES)	A23	WKSTN-O-0064	O	64
006219	SERVICE MANAGER I	A21	WKSTN-O-0064	O	64
006220	SERVICE MANAGER II	A24	WKSTN-O-0064	O	64
006080	SHEET METAL WORKER	A17	WKSTN-O-0064	O	64
006394	SIGN MAKER I	A12	WKSTN-O-0064	O	64
006395	SIGN MAKER II	A16	WKSTN-O-0064	O	64
005199	SOCIAL SERVICE WORKER I	A18	WKSTN-O-0064	O	64
005200	SOCIAL SERVICE WORKER II	A20	WKSTN-O-0064	O	64
008201	SOCIAL SERVICES MANAGER B1	1	WKSTN-O-0120	O	120
008202	SOCIAL SERVICES MANAGER B2	2	WKSTN-O-0120	O	120
008203	SOCIAL SERVICES MANAGER B3	3	WKSTN-O-0120	O	120
004780	SOIL SCIENTIST I	A18	WKSTN-O-0064	O	64
004781	SOIL SCIENTIST II	A22	WKSTN-O-0064	O	64
004782	SOIL SCIENTIST III	A25	WKSTN-O-0064	O	64
004783	SOIL SCIENTIST IV	A28	WKSTN-O-0096	O	96
008562	SPECIAL AGENT (LIQUOR CONTROL)	A25	WKSTN-O-0064	O	64
009875	SPECIAL ASSISTANT - OFFICE AND CLERICAL		WKSTN-O-0064	O	64
009870	SPECIAL ASSISTANT - OFFICIAL AND ADMINISTRATOR		WKSTN-O-0064	O	64
009874	SPECIAL ASSISTANT - PARAPROFESSIONAL		WKSTN-O-0064	O	64
009871	SPECIAL ASSISTANT - PROFESSIONAL		WKSTN-O-0064	O	64
009873	SPECIAL ASSISTANT - PROTECTIVE SERVICE WORKER		WKSTN-O-0064	O	64
039877	SPECIAL ASSISTANT - SERVICE MAINTENANCE		WKSTN-O-0064	O	64
009876	SPECIAL ASSISTANT - SKILLED CRAFT WORKER		WKSTN-O-0064	O	64
009872	SPECIAL ASSISTANT - TECHNICIAN		WKSTN-O-0064	O	64
003045	SPECIAL EDUCATION TEACHER I	A18	WKSTN-O-0064	O	64
003046	SPECIAL EDUCATION TEACHER II	A22	WKSTN-O-0064	O	64
003047	SPECIAL EDUCATION TEACHER III	A24	WKSTN-O-0064	O	64
000920	SPECIAL HEALTH CARE NEEDS REGIONAL COORDINATOR	A28	WKSTN-O-0096	O	96
004466	SPEECH-LANGUAGE PATHOLOGIST	A24	WKSTN-O-0064	O	64
004471	SPEECH-LANGUAGE PATHOLOGY ASSISTANT I	A18	WKSTN-O-0064	O	64
004472	SPEECH-LANGUAGE PATHOLOGY ASSISTANT II	A20	WKSTN-O-0064	O	64
004596	STAFF DEVELOPMENT OFFICER (MENTAL HEALTH)	A26	WKSTN-O-0096	O	96
009712	STAFF DIRECTOR		OFFICE-P-0120	P	120* ¹
009863	STAFF PHYSICIAN		WKSTN-O-0120	O	120
009864	STAFF PHYSICIAN SPECIALIST		WKSTN-O-0120	O	120
000490	STAFF TRAINING & DEVELOPMENT COORDINATOR	A29	WKSTN-O-0096	O	96
005197	STATE CONSULTANT ON CHILD WELFARE	A25	WKSTN-O-0064	O	64

Statewide Space Standards

Issue Date: April 16, 2007

Proprietary
Version: 1.1.7
Page 21 of 55

TITLE CODE	CLASS TITLE	GRADE	FUNCTIONAL WORK SPACE CODE	WORK SPACE STANDARD	
				PRIVATE/ OPEN	PERSONAL SPACE STANDARD
000468	STATE DEMOGRAPHER	A33	WKSTN-O-0120	O	120
009700	STATE DEPARTMENT DIRECTOR		OFFICE-P-0240	P	240*1
007555	STATE FAIR EVENTS/CONCESSIONS COORDINATOR	A26	WKSTN-O-0064	O	64
007350	STATE HAZARD MITIGATION OFFICER	A28	WKSTN-O-0096	O	96
000261	STATE LEASING COORDINATOR	A28	WKSTN-O-0096	O	96
007360	STATE VETERANS CEMETERY WORKER	A11	WKSTN-O-0064	O	64
007349	STATEWIDE VOLUNTEER COORDINATOR (SEMA)	A29	WKSTN-O-0096	O	96
006103	STATIONARY ENGINEER	A20	WKSTN-O-0064	O	64
009770	STOREKEEPER		WKSTN-O-0064	O	64
000202	STOREKEEPER I	A12	WKSTN-O-0064	O	64
000204	STOREKEEPER II	A15	WKSTN-O-0064	O	64
000201	STORES CLERK	A07	WKSTN-O-0048	O	48
009743	STUDENT INTERN		WKSTN-O-0036	O	36
009745	STUDENT WORKER		WKSTN-O-0036	O	36
004491	SUBSTANCE ABUSE COUNSELOR ASSISTANT I	A12	WKSTN-O-0096	O	96
004492	SUBSTANCE ABUSE COUNSELOR ASSISTANT II	A15	WKSTN-O-0096	O	96
004493	SUBSTANCE ABUSE COUNSELOR I	A18	WKSTN-O-0096	O	96
004494	SUBSTANCE ABUSE COUNSELOR II	A21	WKSTN-O-0096	O	96
004495	SUBSTANCE ABUSE COUNSELOR III	A23	WKSTN-O-0096	O	96
004496	SUBSTANCE ABUSE UNIT SUPERVISOR	A26	WKSTN-O-0096	O	96
000581	SUPERVISOR OF VOLUNTEER SERVICES	A16	WKSTN-O-0064	O	64
000205	SUPPLY MANAGER I	A19	WKSTN-O-0064	O	64
000206	SUPPLY MANAGER II	A21	WKSTN-O-0064	O	64
007650	TAX AUDIT REVIEW SPECIALIST	A30	WKSTN-O-0096	O	96
007654	TAX AUDIT SUPERVISOR	A29	WKSTN-O-0096	O	96
007651	TAX AUDITOR I	A21	WKSTN-O-0064	O	64
007652	TAX AUDITOR II	A24	WKSTN-O-0064	O	64
007653	TAX AUDITOR III	A26	WKSTN-O-0096	O	96
007606	TAX COLLECTION TECHNICIAN I	A10	WKSTN-O-0064	O	64
007607	TAX COLLECTION TECHNICIAN II	A13	WKSTN-O-0064	O	64
007608	TAX COLLECTION TECHNICIAN III	A16	WKSTN-O-0064	O	64
008207	TAX COMMISSION MANAGER B1	1	WKSTN-O-0120	O	120
008208	TAX COMMISSION MANAGER B2	2	WKSTN-O-0120	O	120
008209	TAX COMMISSION MANAGER B3	3	WKSTN-O-0120	O	120
007601	TAX PROCESSING TECHNICIAN I	A10	WKSTN-O-0064	O	64
007602	TAX PROCESSING TECHNICIAN II	A13	WKSTN-O-0064	O	64
007603	TAX PROCESSING TECHNICIAN III	A16	WKSTN-O-0064	O	64
007604	TAX PROCESSING TECHNICIAN IV	A19	WKSTN-O-0064	O	64
009758	TAX SEASON ASSISTANT		WKSTN-O-0064	O	64
007614	TAXPAYER SERVICES OFFICE MANAGER	A25	WKSTN-O-0096	O	96
007610	TAXPAYER SERVICES REPRESENTATIVE I	A14	WKSTN-O-0064	O	64
007611	TAXPAYER SERVICES REPRESENTATIVE II	A17	WKSTN-O-0064	O	64
007613	TAXPAYER SERVICES SUPERVISOR	A22	WKSTN-O-0064	O	64
009838	TEACHER		WKSTN-O-0064	O	64
004716	TECHNICAL ASSISTANT I	A11	WKSTN-O-0064	O	64
004717	TECHNICAL ASSISTANT II	A14	WKSTN-O-0064	O	64
004718	TECHNICAL ASSISTANT III	A18	WKSTN-O-0064	O	64
004719	TECHNICAL ASSISTANT IV	A21	WKSTN-O-0064	O	64
000693	TELECOMMUNICATIONS ANALYST I	A20	WKSTN-O-0064	O	64
000694	TELECOMMUNICATIONS ANALYST II	A23	WKSTN-O-0064	O	64
000695	TELECOMMUNICATIONS ANALYST III	A26	WKSTN-O-0096	O	96
000696	TELECOMMUNICATIONS ANALYST IV	A30	WKSTN-O-0096	O	96
000691	TELECOMMUNICATIONS TECHNICIAN I	A17	WKSTN-O-0064	O	64
000692	TELECOMMUNICATIONS TECHNICIAN II	A21	WKSTN-O-0064	O	64
007621	TELEPHONE INFORMATION OPERATOR I (REVENUE)	A10	WKSTN-O-0048	O	48
007622	TELEPHONE INFORMATION OPERATOR II (REVENUE)	A13	WKSTN-O-0048	O	48
000482	TOURIST ASSISTANT	A10	WKSTN-O-0048	O	48
000483	TOURIST CENTER SUPERVISOR	A18	WKSTN-O-0064	O	64
000481	TOURIST GUIDE	A07	WKSTN-O-0048	O	48
004566	TOXICOLOGIST	A32	WKSTN-O-0120	O	120
006023	TRACTOR TRAILER DRIVER	A18	WKSTN-O-0064	O	64
009744	TRAINEE		WKSTN-O-0036	O	36

Statewide Space Standards

Issue Date: April 16, 2007

Proprietary
Version: 1.1.7
Page 22 of 55

TITLE CODE	CLASS TITLE	GRADE	FUNCTIONAL WORK SPACE CODE	WORK SPACE STANDARD	
				PRIVATE/ OPEN	PERSONAL SPACE STANDARD
009800	TRAINING CONSULTANT		WKSTN-O-0064	O	64
009799	TRAINING SPECIALIST		WKSTN-O-0064	O	64
000491	TRAINING TECHNICIAN I	A22	WKSTN-O-0064	O	64
000492	TRAINING TECHNICIAN II	A25	WKSTN-O-0064	O	64
000493	TRAINING TECHNICIAN III	A28	WKSTN-O-0096	O	96
009753	TYPIST		WKSTN-O-0048	O	48
000714	UNEMPLOYMENT INSURANCE AUDITOR I	A19	WKSTN-O-0064	O	64
000715	UNEMPLOYMENT INSURANCE AUDITOR II	A21	WKSTN-O-0064	O	64
000716	UNEMPLOYMENT INSURANCE AUDITOR III	A24	WKSTN-O-0064	O	64
004545	UNIT PROGRAM SUPERVISOR (MENTAL HEALTH)	A24	WKSTN-O-0096	O	96
000610	UNIT SUPERVISOR-MERIT SYSTEM (CRT) (TRNS)	A24	WKSTN-O-0096	O	96
007825	UTILITY ENGINEERING SPECIALIST I	A28	WKSTN-O-0096	O	96
007826	UTILITY ENGINEERING SPECIALIST II	A30	WKSTN-O-0096	O	96
007827	UTILITY ENGINEERING SPECIALIST III	A32	WKSTN-O-0120	O	120
007815	UTILITY MANAGEMENT ANALYST I	A18	WKSTN-O-0064	O	64
007816	UTILITY MANAGEMENT ANALYST II	A23	WKSTN-O-0064	O	64
007817	UTILITY MANAGEMENT ANALYST III	A28	WKSTN-O-0096	O	96
007835	UTILITY OPERATIONS TECHNICAL SPECIALIST I	A24	WKSTN-O-0064	O	64
007836	UTILITY OPERATIONS TECHNICAL SPECIALIST II	A26	WKSTN-O-0096	O	96
007837	UTILITY OPERATIONS TECHNICAL SUPERVISOR	A28	WKSTN-O-0096	O	96
007820	UTILITY POLICY ANALYST I	A28	WKSTN-O-0096	O	96
007821	UTILITY POLICY ANALYST II	A32	WKSTN-O-0120	O	120
007800	UTILITY REGULATORY AUDITOR I	A21	WKSTN-O-0064	O	64
007801	UTILITY REGULATORY AUDITOR II	A24	WKSTN-O-0064	O	64
007802	UTILITY REGULATORY AUDITOR III	A26	WKSTN-O-0096	O	96
007803	UTILITY REGULATORY AUDITOR IV	A29	WKSTN-O-0096	O	96
007804	UTILITY REGULATORY AUDITOR V	A32	WKSTN-O-0120	O	120
007828	UTILITY REGULATORY ENGINEER I	A32	WKSTN-O-0120	O	120
007829	UTILITY REGULATORY ENGINEER II	A34	WKSTN-O-0120	O	120
007830	UTILITY REGULATORY ENGINEERING SUPERVISOR	A35	OFFICE-P-0120	P	120* ¹
008210	UTILITY REGULATORY MANAGER B1	1	WKSTN-O-0120	O	120
008211	UTILITY REGULATORY MANAGER B2	2	WKSTN-O-0120	O	120
008212	UTILITY REGULATORY MANAGER B3	3	WKSTN-O-0120	O	120
004548	VENDOR SERVICES COORDINATOR (MENTAL HEALTH)	A23	WKSTN-O-0064	O	64
005387	VETERANS BENEFITS CLAIMS REPRESENTATIVE	A19	WKSTN-O-0064	O	64
005385	VETERANS SERVICE ASSISTANT	A16	WKSTN-O-0064	O	64
005380	VETERANS SERVICE OFFICER	A17	WKSTN-O-0096	O	96
005383	VETERANS SERVICE SUPERVISOR	A22	WKSTN-O-0096	O	96
007548	VETERINARIAN I	A30	WKSTN-O-0096	O	96
007549	VETERINARIAN II	A32	WKSTN-O-0120	O	120
007551	VETERINARY EPIDEMIOLOGIST	A35	OFFICE-P-0120	P	120* ¹
007550	VETERINARY LABORATORY MANAGER	A32	WKSTN-O-0120	O	120
006376	VIDEO PRODUCTION SPECIALIST I	A18	WKSTN-O-0064	O	64
006377	VIDEO PRODUCTION SPECIALIST II	A22	WKSTN-O-0064	O	64
003017	VOCATIONAL EDUCATION SUPERVISOR	A26	WKSTN-O-0096	O	96
006289	VOCATIONAL ENTERPRISES ANALYST	A27	WKSTN-O-0096	O	96
006285	VOCATIONAL ENTERPRISES DISTRIBUTION SUPERVISOR	A22	WKSTN-O-0064	O	64
006222	VOCATIONAL ENTERPRISES JOBS COORDINATOR	A21	WKSTN-O-0064	O	64
006286	VOCATIONAL ENTERPRISES MARKETING COORDINATOR	A27	WKSTN-O-0096	O	96
006287	VOCATIONAL ENTERPRISES REPRESENTATIVE	A20	WKSTN-O-0064	O	64
006288	VOCATIONAL ENTERPRISES SALES MANAGER	A24	WKSTN-O-0064	O	64
006214	VOCATIONAL ENTERPRISES SUPERVISOR I	A15	WKSTN-O-0064	O	64
006215	VOCATIONAL ENTERPRISES SUPERVISOR II	A17	WKSTN-O-0064	O	64
005172	VOCATIONAL REHABILITATION COUNSELOR FOR THE BLIND	A22	WKSTN-P-0120	P	120* ¹
004412	VOCATIONAL REHABILITATION SPECIALIST I	A20	WKSTN-O-0064	O	64
004413	VOCATIONAL REHABILITATION SPECIALIST II	A23	WKSTN-O-0064	O	64
003070	VOCATIONAL TEACHER I	A18	WKSTN-O-0064	O	64
003071	VOCATIONAL TEACHER II	A21	WKSTN-O-0064	O	64
003072	VOCATIONAL TEACHER III	A23	WKSTN-O-0064	O	64
000888	WAGE AND HOUR INVESTIGATOR I	A18	WKSTN-O-0064	O	64
000889	WAGE AND HOUR INVESTIGATOR II	A23	WKSTN-O-0064	O	64
000890	WAGE AND HOUR INVESTIGATOR III	A25	WKSTN-O-0064	O	64

Statewide Space Standards

Issue Date: April 16, 2007

Proprietary
Version: 1.1.7
Page 23 of 55

TITLE CODE	CLASS TITLE	GRADE	FUNCTIONAL WORK SPACE CODE	WORK SPACE STANDARD	
				PRIVATE/ OPEN	PERSONAL SPACE STANDARD
007214	WATER PATROL CORPORAL	A26	WKSTN-O-0064	O	64
007218	WATER PATROL LIEUTENANT	A29	WKSTN-O-0120	O	120
007212	WATER PATROL OFFICER	A24	WKSTN-O-0064	O	64
007210	WATER PATROL RECRUIT	A22	WKSTN-O-0064	O	64
007216	WATER PATROL SERGEANT	A28	WKSTN-O-0096	O	96
004645	WATER SPECIALIST I	A20	WKSTN-O-0064	O	64
004646	WATER SPECIALIST II	A23	WKSTN-O-0064	O	64
004647	WATER SPECIALIST III	A25	WKSTN-O-0064	O	64
007537	WEIGHTS AND MEASURES INSPECTOR I	A17	WKSTN-O-0064	O	64
007538	WEIGHTS AND MEASURES INSPECTOR II	A19	WKSTN-O-0064	O	64
004411	WORK ADJUSTMENT TRAINING SUPERVISOR	A14	WKSTN-O-0064	O	64
004435	WORK THERAPY SPECIALIST I	A11	WKSTN-O-0064	O	64
004436	WORK THERAPY SPECIALIST II	A15	WKSTN-O-0064	O	64
009825	WORKER (FARM, DAIRY & GROUNDS)		WKSTN-O-0048	O	48
000881	WORKERS' COMPENSATION SAFETY CONSULTANT I	A21	WKSTN-O-0064	O	64
000882	WORKERS' COMPENSATION SAFETY CONSULTANT II	A25	WKSTN-O-0064	O	64
007580	WORKERS' COMPENSATION SPECIALIST	A24	WKSTN-O-0064	O	64
000601	WORKERS' COMPENSATION TECHNICIAN I	A12	WKSTN-O-0064	O	64
000602	WORKERS' COMPENSATION TECHNICIAN II	A14	WKSTN-O-0064	O	64
000603	WORKERS' COMPENSATION TECHNICIAN SUPERVISOR	A18	WKSTN-O-0096	O	96
000600	WORKERS' COMPENSATION TRAINEE	A10	WKSTN-O-0048	O	48
007925	WORKFORCE DEVELOPMENT DEPUTY	A14	WKSTN-O-0064	O	64
007928	WORKFORCE DEVELOPMENT SPECIALIST I	A17	WKSTN-O-0064	O	64
007929	WORKFORCE DEVELOPMENT SPECIALIST II	A19	WKSTN-O-0064	O	64
007930	WORKFORCE DEVELOPMENT SPECIALIST III	A23	WKSTN-O-0064	O	64
007931	WORKFORCE DEVELOPMENT SPECIALIST IV	A27	WKSTN-O-0096	O	96
007934	WORKFORCE DEVELOPMENT SUPERVISOR I	A20	WKSTN-O-0096	O	96
007935	WORKFORCE DEVELOPMENT SUPERVISOR II	A22	WKSTN-O-0096	O	96
007936	WORKFORCE DEVELOPMENT SUPERVISOR III	A24	WKSTN-O-0096	O	96
004444	WORKSHOP PROGRAM COORDINATOR	A23	WKSTN-O-0064	O	64
004437	WORKSHOP SUPERVISOR I	A10	WKSTN-O-0048	O	48
004438	WORKSHOP SUPERVISOR II	A13	WKSTN-O-0048	O	48
005045	YOUTH FACILITY MANAGER I	A24	WKSTN-O-0096	O	96
005046	YOUTH FACILITY MANAGER II	A25	WKSTN-O-0096	O	96
005079	YOUTH GROUP LEADER	A20	WKSTN-O-0064	O	64
005076	YOUTH SPECIALIST I	A15	WKSTN-O-0064	O	64
005077	YOUTH SPECIALIST II	A18	WKSTN-O-0064	O	64

Note: *1 - Square footage subject to change based on actual building layout.

*2 - Shared workstation.

SECTION C. FOOTPRINT GUIDELINES FOR INDIVIDUAL SPACES

Work spaces designed for the task and function of an individual's job has been found to be more efficient. The typical 8' x 8' footprint (64 square feet) is the standard workspace size for the majority of staff functions and offers the greatest flexibility and benefit. Smaller (6' x 6' and 6' x 8') and larger (8' x 12' and 10' x 12') footprints have also been included. The smaller standard may be used for individuals whose task and functions determine the smaller area, such as part-time, telecommuting and data entry functions. The larger footprints may be used for individuals whose task and functions necessitate larger meeting areas or require special consideration for large documents or special equipment within their space.

The suggested Work Space Standards are intended as a planning guide for the State of Missouri offices when new office space is needed or when modifying existing space. It should assist state divisions in designing new office layouts. They are *guidelines* and depend on existing conditions. The following standards are a visual reference to illustrate square footages. Details of panel height and componentry will be determined on a case by case basis. The footprint layouts are enclosed in this section.

The following criteria helped determine functional issues for individual footprints: paperwork/task, computer/equipment, work surface use, filing/reference and privacy needs, all measured by high, moderate or low usage. Conferencing was measured by either answering yes with the number of users, or no.

Position titles and job codes, along with grade level are enclosed in **Section B** of this document that defines an acceptable footprint. Refer to <http://www.oa.mo.gov/fmdc/> under the **State Agency Information** section to access the most current Statewide Space Standards Manual reflecting monthly class title modifications.

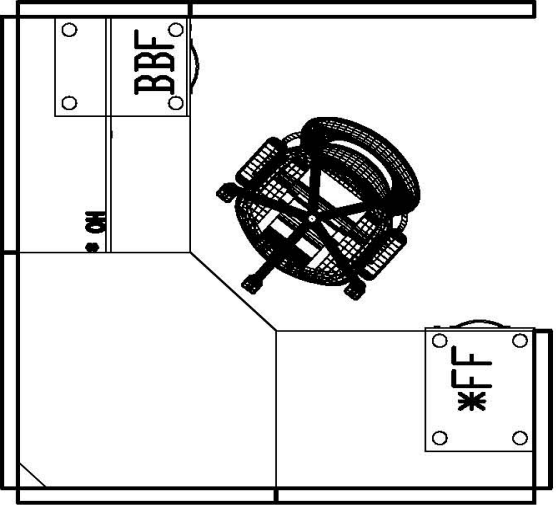
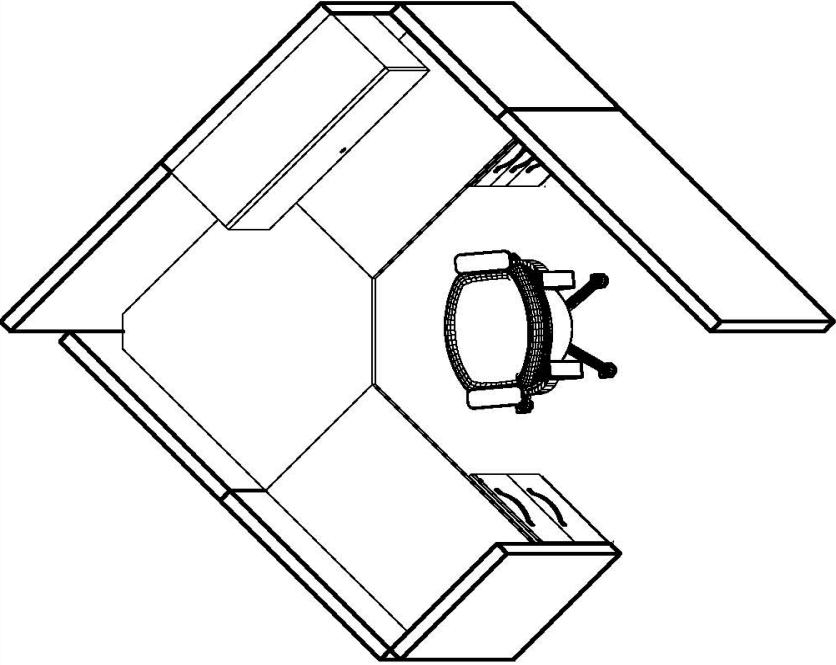
<p>WKSTN-0-0036</p>		<p>*NOTE: ONE ADDITIONAL FILE CABINET MAY BE ADDED AS NEEDED. *NOTE: ONE OVERHEAD COMPARTMENT MAY BE ADDED AS NEEDED.</p>	<p>6x6 TYPICAL 36 SQ FT DATE: 03-24-06</p>
	<p>FUNCTIONAL ASSIGNMENT: THIS IS A STANDARD WORKSPACE SIZE FOR ALL PART-TIME NON-SUPERVISORY FUNCTIONS THAT REQUIRE SPECIAL CONSIDERATION FOR THE FOLLOWING: PAPERWORK/TASK: MODERATE COMPUTER/EQUIPMENT USE: LOW WORKSURFACE USE: LOW FILING/REFERENCE: LOW CONFERENCING: NONE PRIVACY - VISUAL/ACOUSTICAL: LOW</p>	<p>STATE OF MISSOURI STATEWIDE SPACE STANDARDS</p>	

WKSTN-0-0048

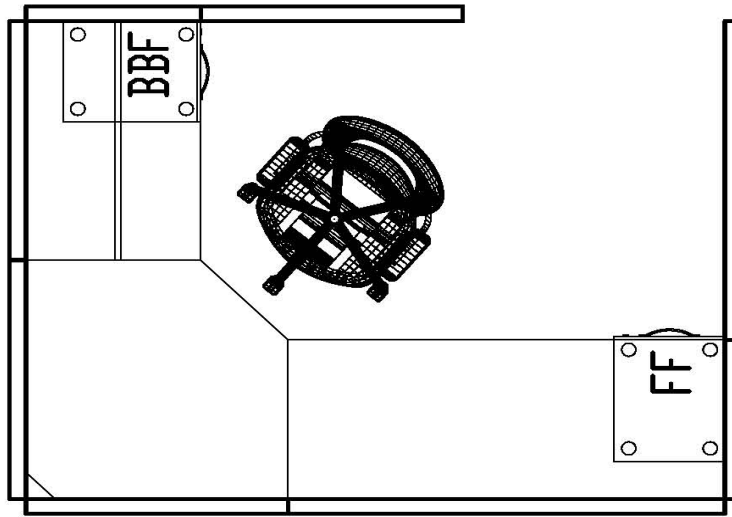
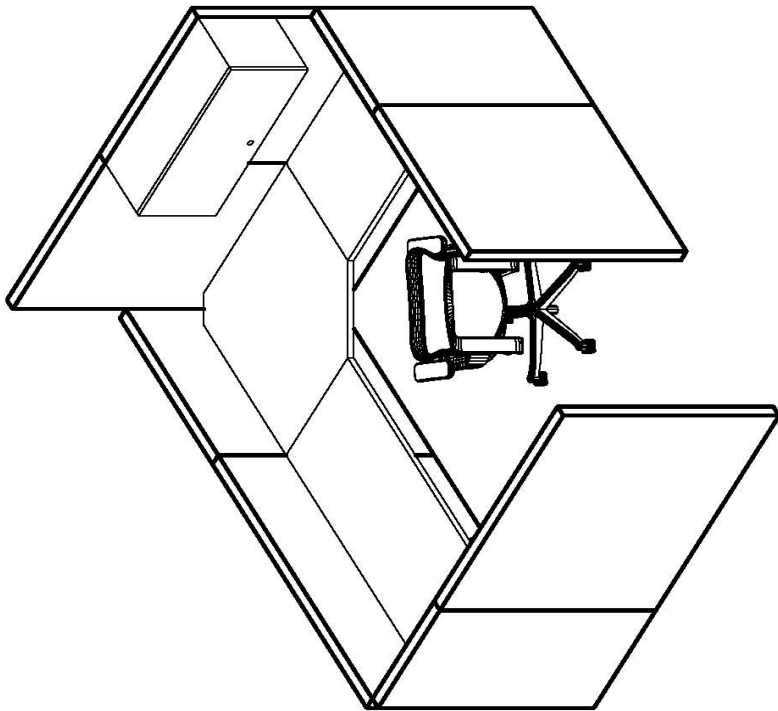

FUNCTIONAL ASSIGNMENT:
THIS IS A STANDARD WORKSPACE SIZE FOR NON-SUPERVISORY
FUNCTIONS THAT REQUIRE SPECIAL CONSIDERATION
FOR THE FOLLOWING:
PAPERWORK/TASK: MODERATE
COMPUTER/EQUIPMENT USE: MODERATE
WORKSURFACE USE: MODERATE
FILING/REFERENCE: MODERATE
CONFERENCING: NONE
PRIVACY - VISUAL /ACOUSTICAL: LOW

6X8 TYPICAL
48 SQ FT
DATE 03-24-06

STATE OF MISSOURI

STATEWIDE SPACE STANDARDS

WKSTN-0-0064A

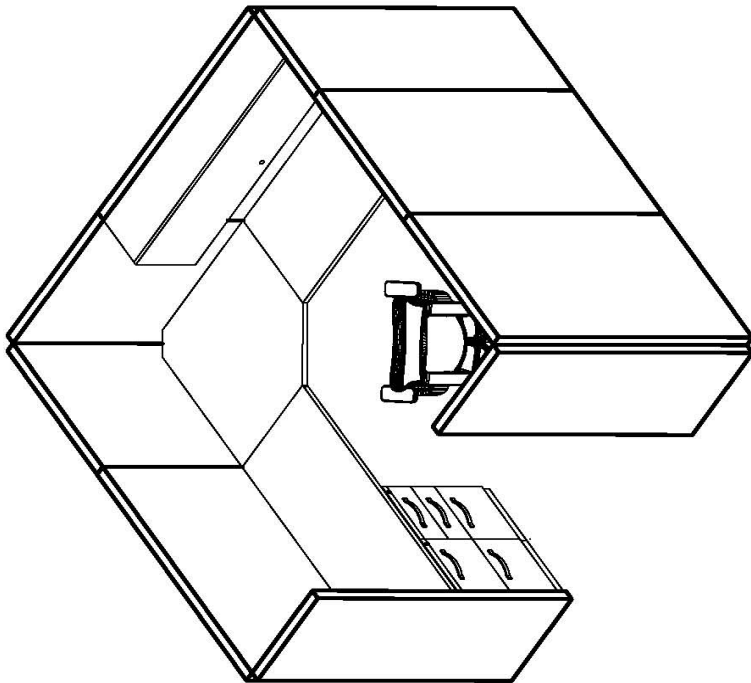
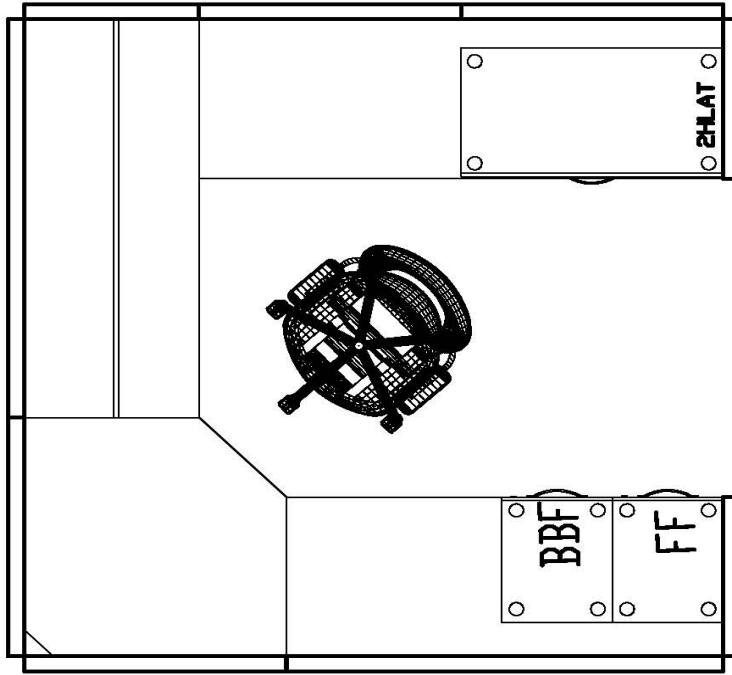

FUNCTIONAL ASSIGNMENT:
 THIS IS A STANDARD WORKSPACE SIZE FOR SEMI-SUPERVISORY
 FUNCTIONS THAT REQUIRE SPECIAL CONSIDERATION FOR THE FOLLOWING:
 PAPERWORK/TASK: MODERATE
 COMPUTER/EQUIPMENT USE: HIGH
 WORKSURFACE USE: HIGH
 FILING/REFERENCE: MODERATE
 CONFERRING: NONE
 PRIVACY - VISUAL/ACOUSTICAL: MODERATE

8X8 "A" TYPICAL

64 SQ FT

DATE
03-24-06

STATE OF MISSOURI

STATEWIDE SPACE STANDARDS

WKSTN-0-0064B

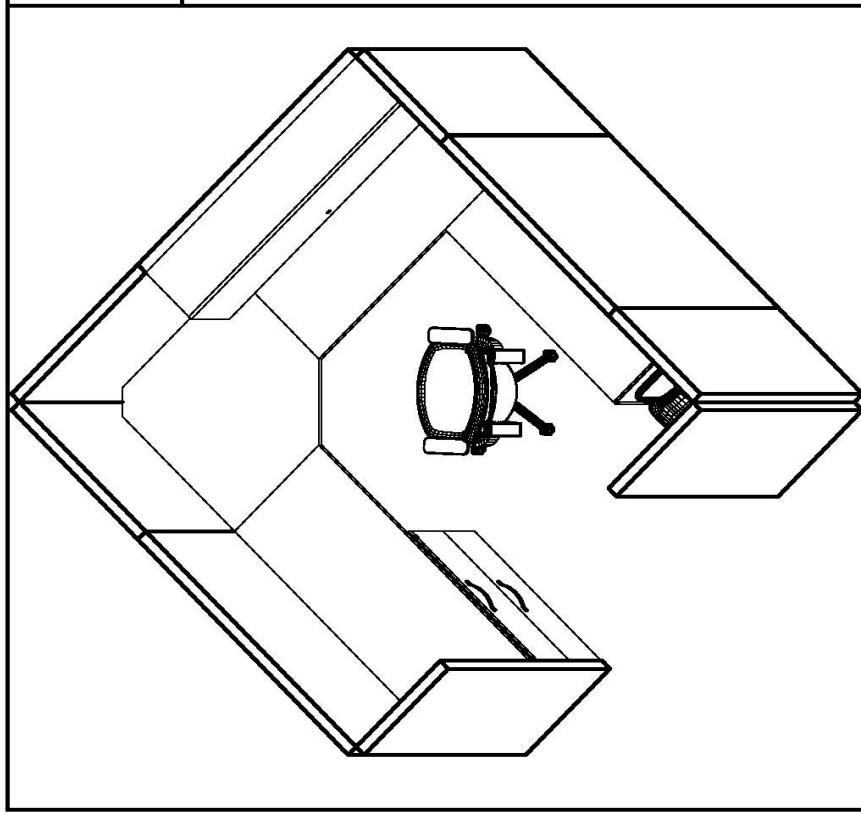
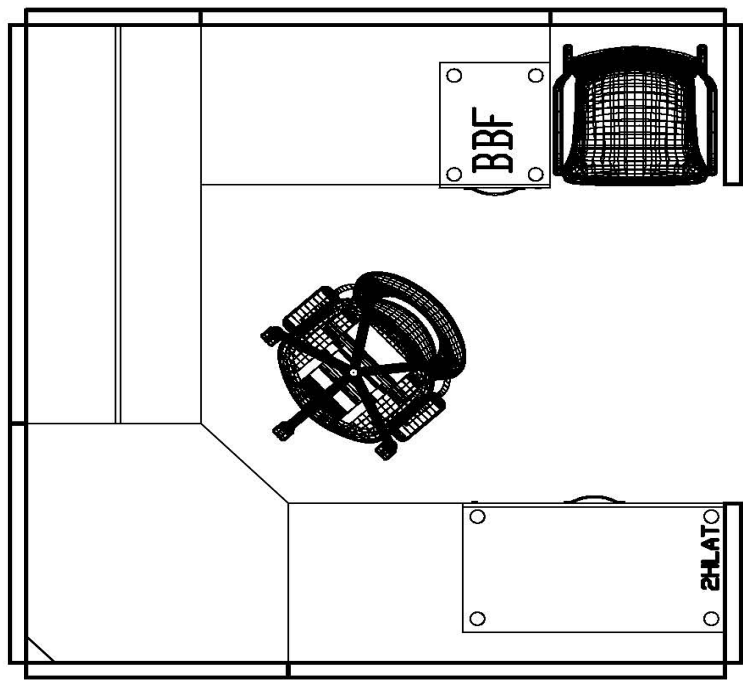

FUNCTIONAL ASSIGNMENT:
 THIS IS A STANDARD WORKSPACE SIZE FOR SEMI-SUPERVISORY
 FUNCTIONS THAT REQUIRE SPECIAL CONSIDERATION FOR THE
 FOLLOWING:
 PAPERWORK/TASK: MODERATE
 COMPUTER/EQUIPMENT USE: MODERATE
 WORKSURFACE USE: HIGH
 FILING/REFERENCE: MODERATE
 CONFERRING: ONE PERSON
 PRIVACY - VISUAL/ ACOUSTICAL: MODERATE

8X8 "B" TYPICAL

64 SQ FT

DATE
03-24-06

STATE OF MISSOURI

STATEWIDE SPACE STANDARDS

WKSTN-0-0064C

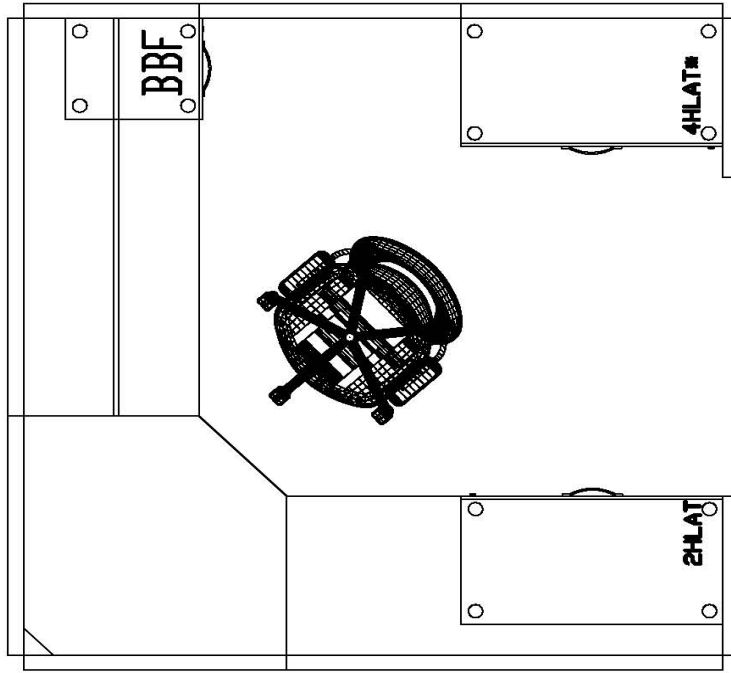

*NOTE: ONE ADDITIONAL FILE CABINET MAY BE ADDED AS NEEDED.

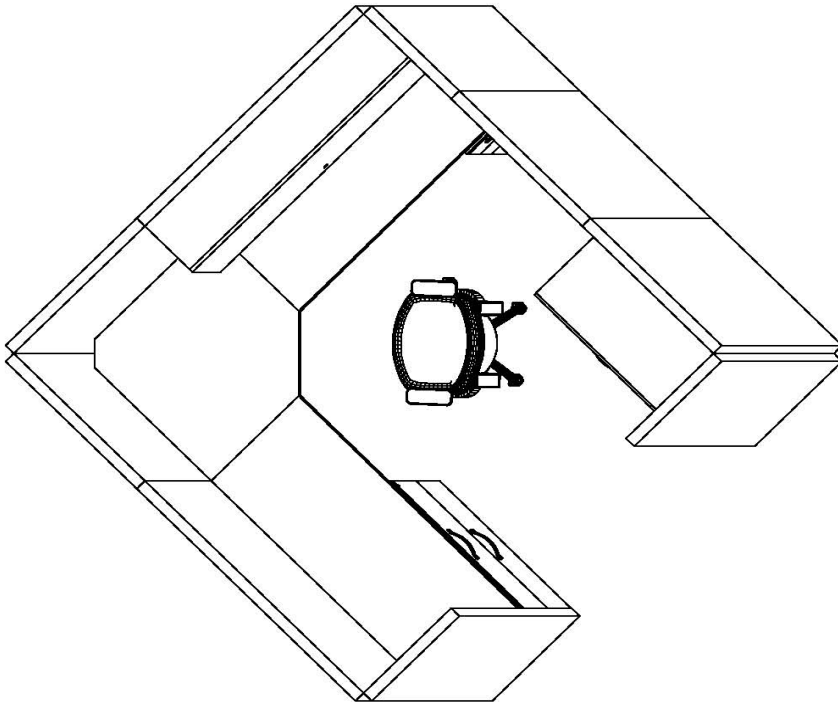

FUNCTIONAL ASSIGNMENT:
THIS IS A STANDARD WORKSPACE SIZE FOR NON-SUPERVISORY FUNCTIONS
THAT REQUIRE SPECIAL CONSIDERATION FOR THE FOLLOWING:
PAPERWORK/TASK: MODERATE
COMPUTER/EQUIPMENT USE: MODERATE
WORKSURFACE USE: MODERATE
FILING/REFERENCE: HIGH
CONFERENCING: NONE
PRIVACY - VISUAL/ ACOUSTICAL: MODERATE

8X8 "C" TYPICAL

64 SQ FT

DATE
03-24-06

STATE OF MISSOURI

STATEWIDE SPACE STANDARDS

WKSTN-0-0064D

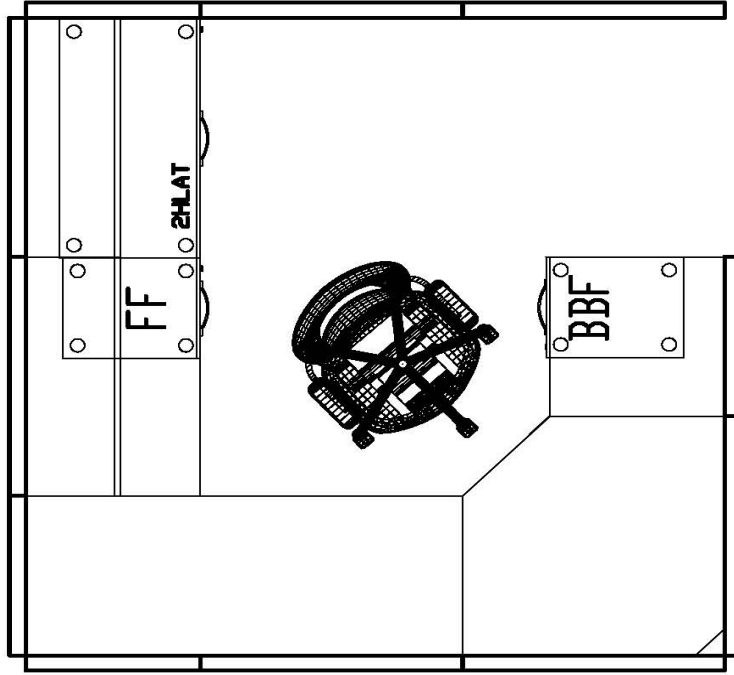
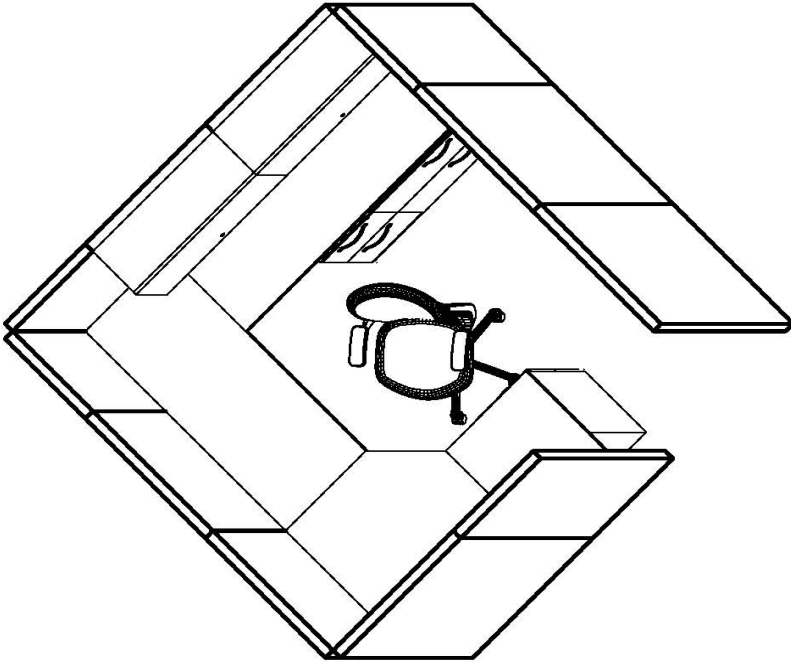

FUNCTIONAL ASSIGNMENT:
 THIS IS A STANDARD WORKSPACE SIZE FOR SEMI-SUPERVISORY
 FUNCTIONS THAT REQUIRE SPECIAL CONSIDERATION FOR THE FOLLOWING:
 PAPERWORK/TASK: MODERATE
 COMPUTER/EQUIPMENT USE: HIGH
 WORKSURFACE USE: HIGH
 FILING/REFERENCE: MODERATE
 CONFERRING: NONE
 PRIVACY - VISUAL/ACOUSTICAL: MODERATE

8X8 "D" TYPICAL

64 SQ FT

DATE
03-24-06

STATE OF MISSOURI

STATEWIDE SPACE STANDARDS

WKSTN-0-0064E

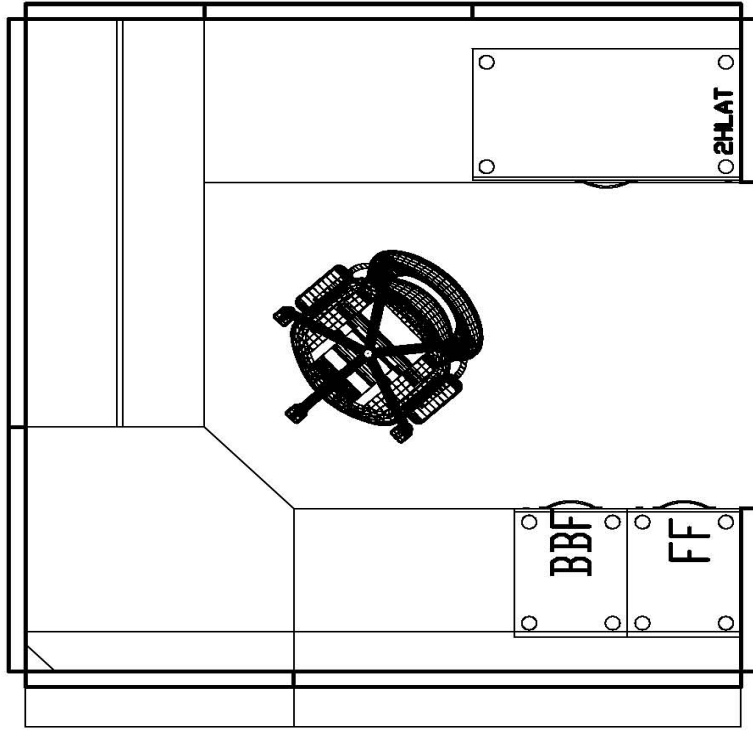
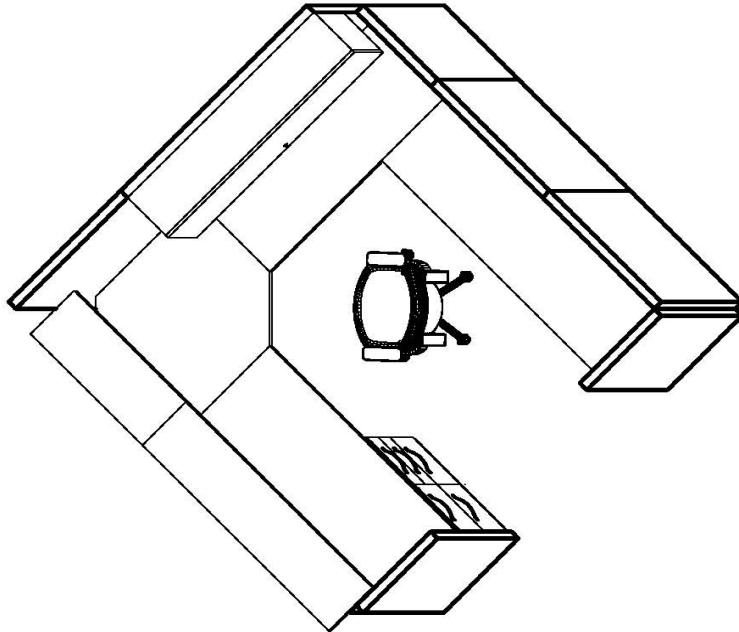

FUNCTIONAL ASSIGNMENT:
 THIS IS A STANDARD WORKSPACE SIZE FOR SEMI-SUPERVISORY
 FUNCTIONS THAT REQUIRE SPECIAL CONSIDERATION FOR THE FOLLOWING:
 PAPERWORK/TASK: MODERATE
 COMPUTER/EQUIPMENT USE: HIGH
 WORKSURFACE USE: HIGH
 FILING/REFERENCE: MODERATE
 CONFERRING: NONE
 PRIVACY - VISUAL/ACOUSTICAL: MODERATE

8X8 "E" TYPICAL

64 SQ FT

DATE
03-24-06

STATE OF MISSOURI
 STATEWIDE SPACE STANDARDS

WKSTN-0-0096A

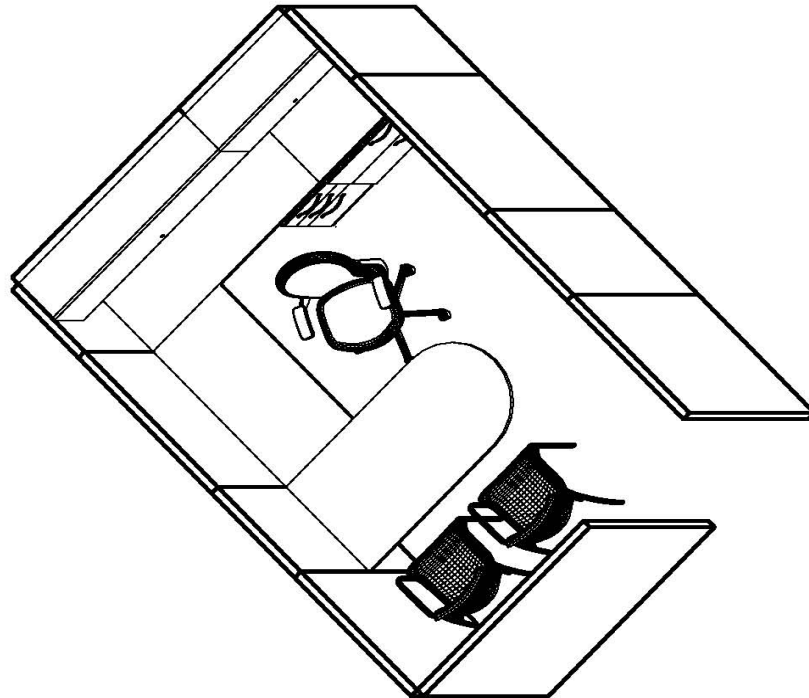
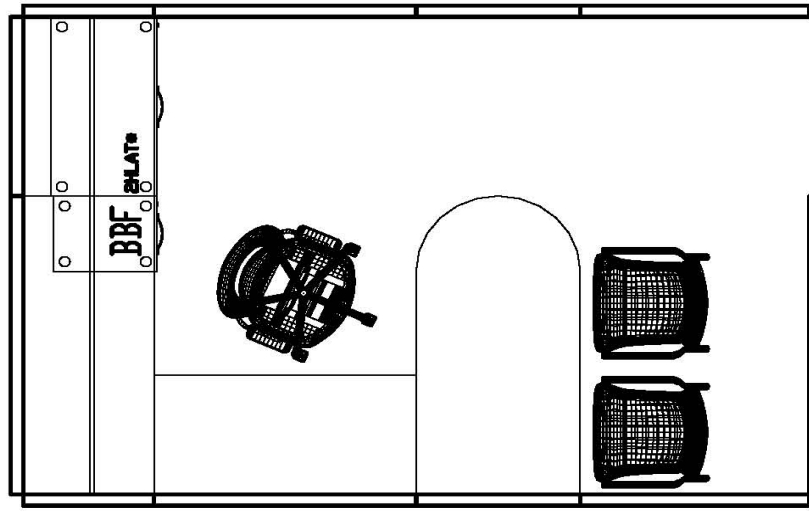

FUNCTIONAL ASSIGNMENT:
 THIS IS A STANDARD WORKSPACE SIZE FOR ALL FRONT LINE SUPERVISOR
 JOB FUNCTIONS AND MANAGERIAL FUNCTIONS THAT REQUIRE
 SPECIAL CONSIDERATION FOR THE FOLLOWING:
 PAPERWORK/TASK: MODERATE
 COMPUTER/EQUIPMENT USE: HIGH
 WORK SURFACE USE: HIGH
 FILING/REFERENCE: MODERATE
 CONFERRING: THREE PEOPLE
 PRIVACY - VISUAL/ACOUSTICAL: MODERATE

*NOTE: FILING MAY CHANGE AS NEEDED.

8X12 "A" TYPICAL
96 SQ FT
DATE 03-24-06

STATE OF MISSOURI

STATEWIDE SPACE STANDARDS

WKSTN-0-0096B

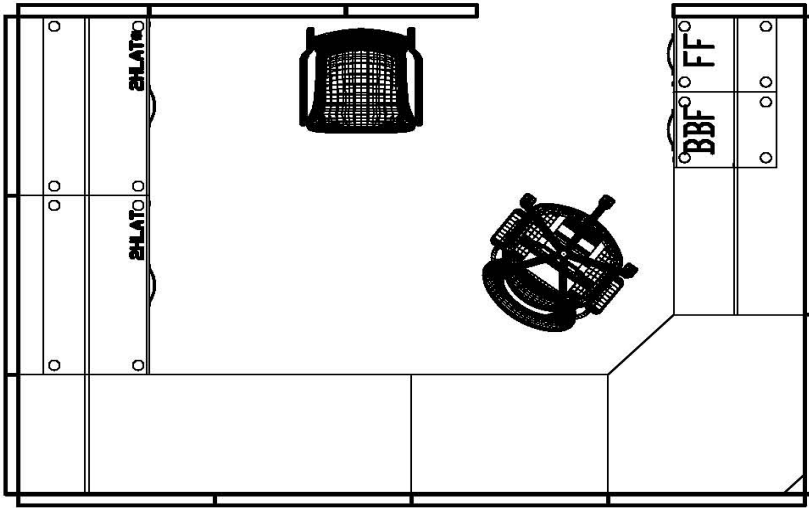

*NOTE: ONE ADDITIONAL TWO DRAWER LATERAL FILE CABINET MAY BE ADDED AS NEEDED.

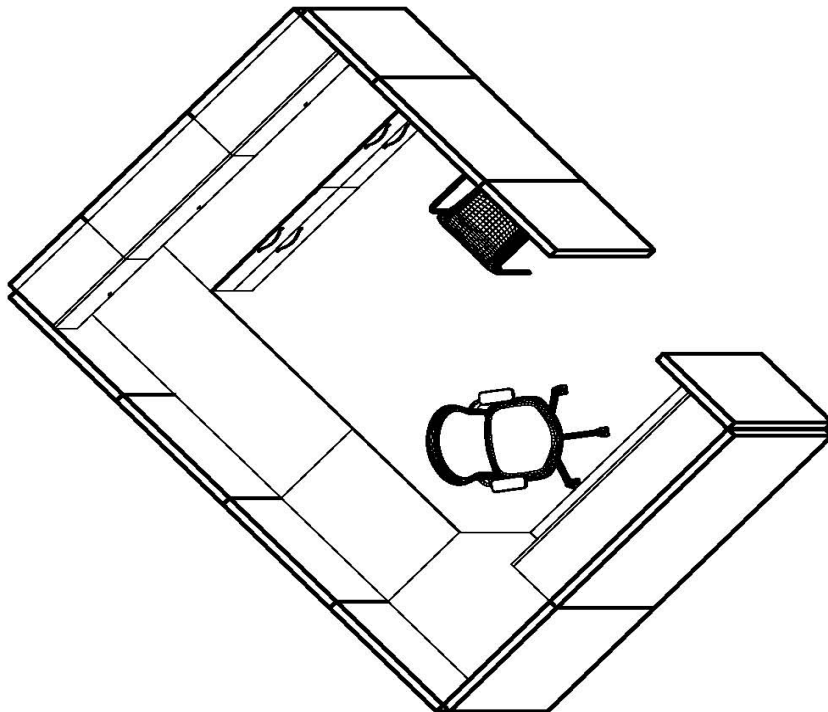

FUNCTIONAL ASSIGNMENT:
 THIS IS A STANDARD WORKSPACE SIZE FOR SEMI-SUPERVISORY
 FUNCTIONS THAT REQUIRE SPECIAL CONSIDERATION FOR THE FOLLOWING:
 PAPERWORK/TASK: HIGH, OVERSIZED DOCUMENTS
 COMPUTER/EQUIPMENT USE: HIGH
 WORKSURFACE USE: HIGH
 FILING/REFERENCE: MODERATE
 CONFERRING: TWO PEOPLE
 PRIVACY - VISUAL/ACOUSTICAL: MODERATE

8X12 "B" TYPICAL
96 SQ FT
DATE 03-24-06

STATE OF MISSOURI
 STATEWIDE SPACE STANDARDS

WKSTN-0-0120

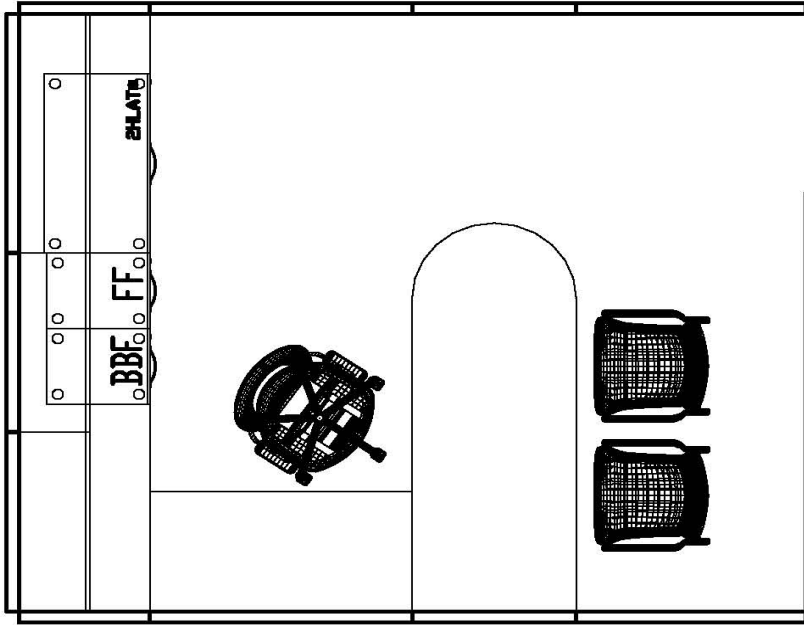

*NOTE: ONE FOUR HIGH LATERAL FILE CABINET MAY BE REPLACED AS NEEDED.

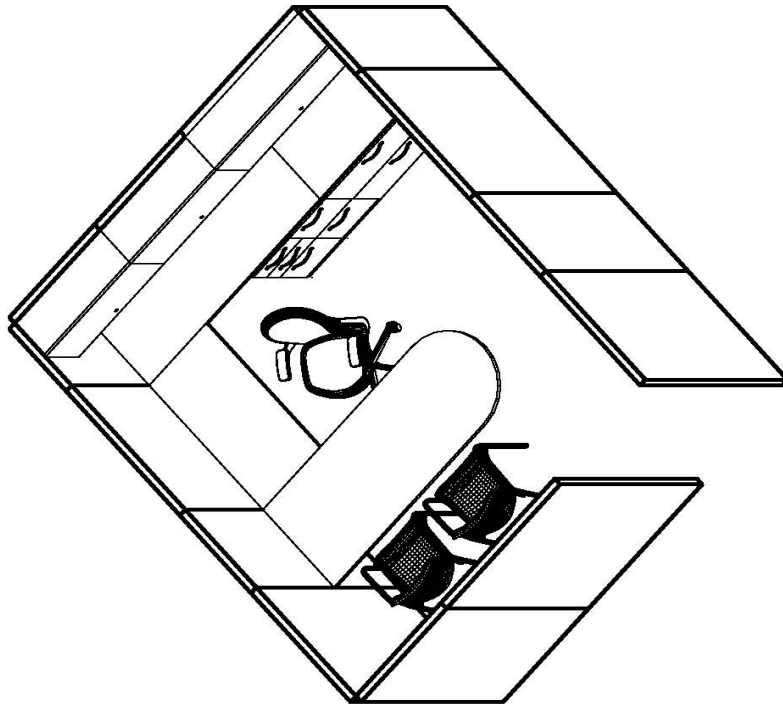

FUNCTIONAL ASSIGNMENT:
 THIS IS A STANDARD WORKSPACE SIZE FOR SOME SUPERVISORY
 JOB FUNCTIONS THAT REQUIRE CONFIDENTIALITY, SECURITY, VISUAL
 AND ACOUSTICAL PRIVACY:
 PAPERWORK/TASK: HIGH
 COMPUTER/EQUIPMENT USE: HIGH
 WORK SURFACE USE: HIGH
 FILING/REFERENCE: HIGH
 CONFERRING: THREE PLUS
 PRIVACY - VISUAL/ACOUSTICAL: MODERATE

10X12 TYPICAL

120 SQ FT

DATE
03-24-06

STATE OF MISSOURI

STATEWIDE SPACE STANDARDS

OFFICE - P-0120

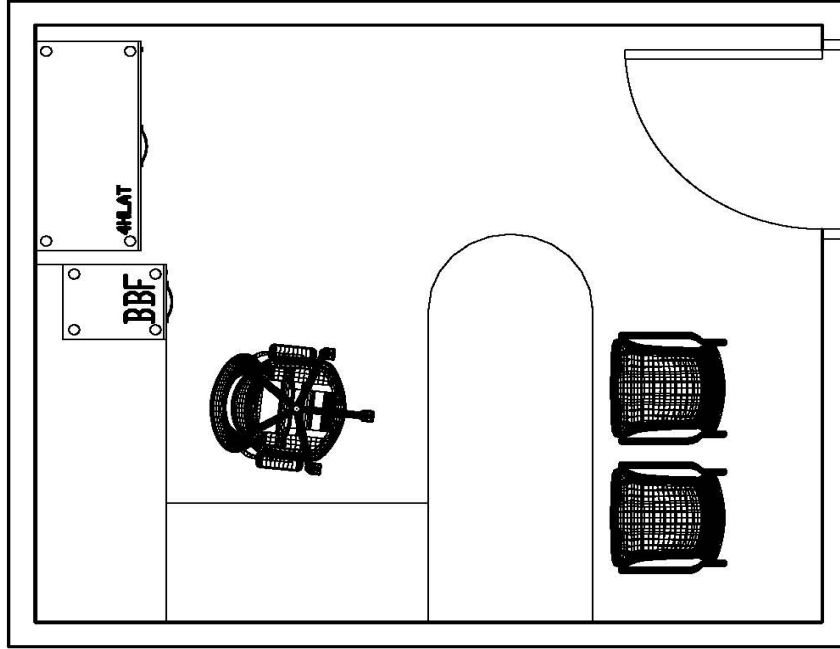
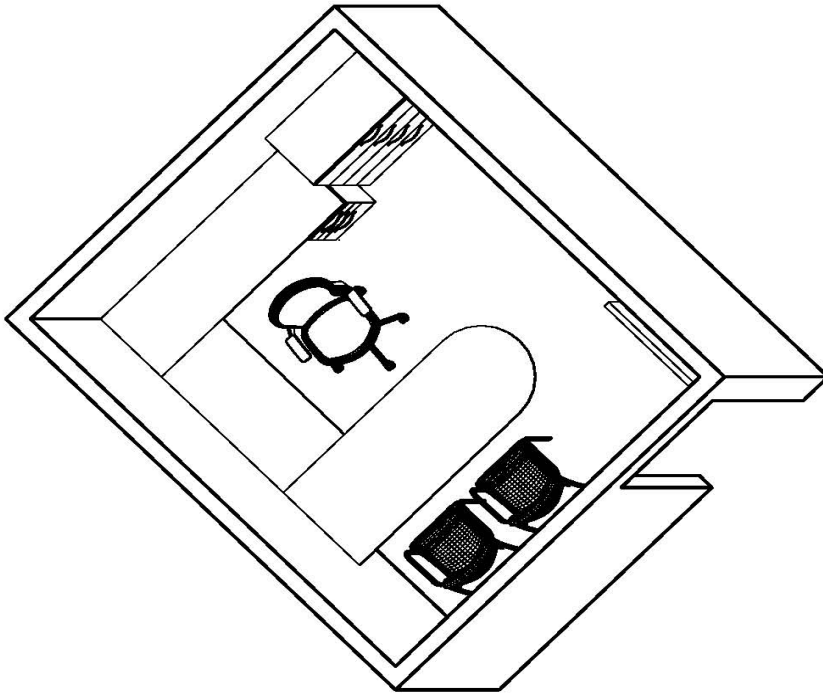

FUNCTIONAL ASSIGNMENT:
 THIS IS A STANDARD WORKSPACE SIZE FOR SOME SUPERVISORY JOB
 FUNCTIONS THAT REQUIRE CONFIDENTIALITY, SECURITY,
 VISUAL AND ACOUSTICAL PRIVACY:
 PAPERWORK/TASK: HIGH
 COMPUTER/EQUIPMENT USE: MODERATE
 WORK SURFACE USE: MODERATE
 FILING/REFERENCE: HIGH
 CONFERRING: THREE PLUS
 PRIVACY - VISUAL/ACOUSTICAL: HIGH

10X12 OFFICE TYPICAL

120 SQ FT

DATE
03-24-06

STATE OF MISSOURI

STATEWIDE SPACE STANDARDS

OFFICE - P-0240

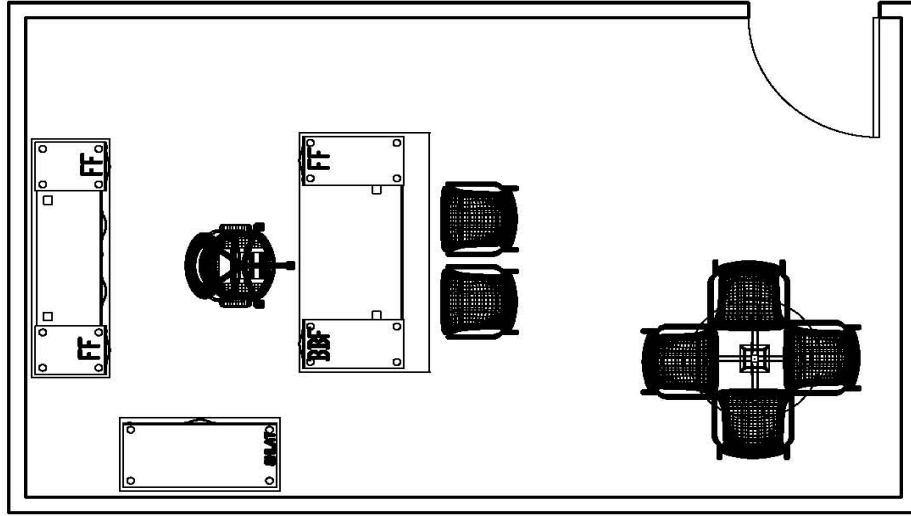
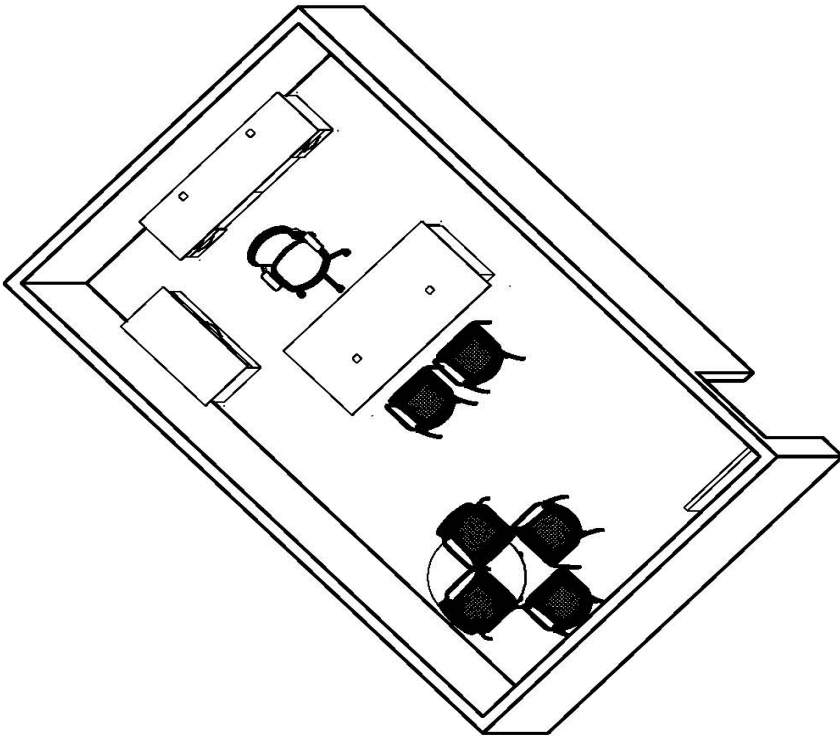

FUNCTIONAL ASSIGNMENT:
 THIS IS A STANDARD WORKSPACE SIZE FOR CERTAIN JOB FUNCTIONS THAT REQUIRE CONFIDENTIALITY, SECURITY, VISUAL AND ACOUSTICAL PRIVACY:
 PAPERWORK/TASK: MODERATE
 COMPUTER/EQUIPMENT USE: MODERATE
 WORK SURFACE USE: MODERATE
 FILING/REFERENCE: MODERATE
 CONFERENCING: FOUR PLUS
 PRIVACY - VISUAL/ACOUSTICAL: HIGH

12X20 OFFICE TYPICAL

240 SQ FT

DATE
03-24-06

STATE OF MISSOURI

STATEWIDE SPACE STANDARDS

SECTION D. GUIDELINES FOR FUNCTIONAL SUPPORT AREAS

Space for areas other than individual work areas are listed in this section. Space has been determined both by examining current State of Missouri functional support standards and by using specialized industry standards.

Within this section, the Room Standard Codes that are listed for each space is made up of three categories. For example, with CONF-P-0240, CONF describes the function of the room (Conference); P identifies private (drywall) or O identifies open; and 0240 defines the square feet allocated for the room (240 square feet).

If a functional need is required outside the standard listing, please document the information in the comments section of the Space Analysis in the Functional Support Area details.

FUNCTIONAL SUPPORT AREA SPACE STANDARDS

**OFFICE OF ADMINISTRATION
DIVISION OF FACILITIES MANAGEMENT
OFFICE & SUPPORT AREA CODES**

FUNCTIONAL TYPE	ROOM STANDARD	STANDARD DESCRIPTION	ALLOCATED AREA	CAPACITY
Common Core	ELEVATOR-0200	Elevator	200	
Common Core	JANITOR-P-0048	Janitor's Closet	48	
Common Core	RESTROOM-CF-0060	Client Rest Room - Female - 1 Person Capacity	60	1
Common Core	RESTROOM-CM-0060	Client Rest Room - Male - 1 Person Capacity	60	1
Common Core	RESTROOM-CU-0060	Client Rest Room - Unisex - 1 Person Capacity	60	1
Common Core	RESTROOM-F-0060	Restroom Facility - Female - 1 Person Capacity	60	1
Common Core	RESTROOM-F-0150	Restroom Facility - Female - 2 Person Capacity	150	2
Common Core	RESTROOM-F-0180	Restroom Facility - Female - 3 Person Capacity	180	3
Common Core	RESTROOM-F-0220	Restroom Facility - Female - 4 Person Capacity	220	4
Common Core	RESTROOM-F-0260	Restroom Facility - Female - 5 Person Capacity	260	5
Common Core	RESTROOM-F-0300	Restroom Facility - Female - 6 Person Capacity	300	6
Common Core	RESTROOM-M-0060	Restroom Facility - Male - 1 Person Capacity	60	1
Common Core	RESTROOM-M-0150	Restroom Facility - Male - 2 Person Capacity	150	2
Common Core	RESTROOM-M-0180	Restroom Facility - Male - 3 Person Capacity	180	3
Common Core	RESTROOM-M-0220	Restroom Facility - Male - 4 Person Capacity	220	4
Common Core	RESTROOM-U-0060	Restroom Facility - Unisex - 1 Person Capacity	60	1
Common Core	SHOWER-F-0150	Shower Facility - Female	150	
Common Core	SHOWER-M-0150	Shower Facility - Male	150	
Equipment	EQUIP-O-0006	Desktop Printer	6	
Equipment	EQUIP-O-0018	Microfiche Viewer/Cabinet	18	
Equipment	EQUIP-O-0020	Small Freestanding Copier / Printer	20	
Equipment	EQUIP-O-0030	Postage/Shredder	30	
Equipment	EQUIP-O-0032	Microfiche Machine 4' x 5'	32	
Equipment	EQUIP-O-0040	Medium Freestanding Copier / Printer	40	
Equipment	EQUIP-O-0050	Miscellaneous Equipment	50	
Equipment	EQUIP-O-0060	Large Freestanding Copier / Printer	60	
Equipment	EQUIP-P-0120	Equipment Room	120	
Furniture	BOOKCASE-O-0006	Bookcase - 36w	6	
Furniture	BOOKCASE-O-0008	Bookcase - 48w	8	
Furniture	CHAIR-O-0012	Guest Chair	12	
Furniture	FILEFLAT-O-0024	Flat File Cabinet (48x36)	24	
Furniture	FILEFLAT-O-0040	Flat File Cabinet (60x48)	40	
Furniture	FILEHANGPLAN-O-0012	Hanging Plan File (18x30)	12	
Furniture	FILEHANGPLAN-O-0028	Hanging Plan File (24x42)	28	
Furniture	FILEHIGHDENS-O-0040	High Density File Unit	40	
Furniture	FILELATERAL-O-0009	Lateral File Cabinet - 36w	9	
Furniture	FILELATERAL-O-0011	Lateral File Cabinet - 42w	11	
Furniture	FILEPEDESTAL-O-0010	Pedestal File Cabinet	10	
Furniture	FILEVERTICAL-O-0009	Vertical File Cabinet	9	
Furniture	STORAGECAB-O-0009	Storage Cabinet - 36w	9	
Furniture	STORAGECAB-O-0014	Storage Cabinet - 48w	14	
Furniture	TABLE-O-0020	Table - 24x48	20	
Furniture	TABLE-O-0028	Table - 30x60	28	
Furniture	TABLE-O-0030	Table - 36" Round	30	
Furniture	TABLE-O-0036	Table - 36x72	36	
Furniture	TABLE-O-0038	Table - 30x84	38	
Furniture	TABLEDRAFT-O-0042	Drafting Table - 48x72	42	
Meeting Space	AUD-P-02500	Auditorium-Small - Seats 175 to 350	2,500	350
Meeting Space	AUD-P-06000	Auditorium-Medium - Seats 351 to 800	6,000	800
Meeting Space	AUD-P-11500	Auditorium-Large - Seats 801 to 1600	11,500	1,600
Meeting Space	CONF-P-0120	Conference Rm - Seats 4 to 6	120	6
Meeting Space	CONF-P-0240	Conference Rm - Seats 7 to 10	240	10
Meeting Space	CONF-P-0360	Conference Rm - Seats 11 to 18	360	18
Meeting Space	CONF-P-0480	Conference Rm - Seats 19 to 25	480	25
Meeting Space	CONF-P-0840	Conference Rm - Seats 26 to 34	840	34

FUNCTIONAL TYPE	ROOM STANDARD	STANDARD DESCRIPTION	ALLOCATED AREA	CAPACITY
Meeting Space	CONF-P-1200	Conference Rm - Seats 35 to 46	1,200	46
Meeting Space	CONF-P-1665	Conference Rm - 1,665 SF (Written Justification)	1,665	
Meeting Space	CONF-P-3000	Conference Rm - 3,000 SF (Written Justification)	3,000	
Meeting Space	FAMILY-P-0120	Family Room	120	
Meeting Space	HEARING-P-0120	Hearing Room	120	
Meeting Space	INTERVIEW-O-0054	Interview Booth - 2 to 3 Person Capacity	54	3
Meeting Space	INTERVIEW-P-0080	Interview Room - 4 Person Capacity	80	4
Meeting Space	OBSERV-P-0048	Observation Room	48	
Meeting Space	TESTING-P-0120	Testing Room	120	
Meeting Space	TRAINING-P-0240	Training Room - Seats 8 to 10	240	10
Meeting Space	TRAINING-P-0480	Training Room - Seats 11 to 19	480	19
Meeting Space	TRAINING-P-0720	Training Room - Seats 20 to 31	720	31
Miscellaneous Areas	BREAK-P-0120	Break Room - Facilities with 1 to 20 People	120	20
Miscellaneous Areas	BREAK-P-0240	Break Room - Facilities with 21 to 50 People	240	50
Miscellaneous Areas	COFFEE-O-0060	Coffee Bar	60	
Miscellaneous Areas	COPY-P-0120	Copy Room	120	
Miscellaneous Areas	DATA COMM-P-0064	Data / Telecommunications Room - Small	64	
Miscellaneous Areas	DATA COMM-P-0080	Data / Telecommunications Room - Medium	80	
Miscellaneous Areas	DATA COMM-P-0100	Data / Telecommunications Room - Large	100	
Miscellaneous Areas	FILE-P-0120	File Room	120	
Miscellaneous Areas	FILE-P-0240	File Room	240	
Miscellaneous Areas	MAIL-P-0120	Mail Room	120	
Miscellaneous Areas	MAIL COPY-P-0120	Mail / Copy Room	120	
Miscellaneous Areas	PANTRY-P-0080	Pantry	80	
Miscellaneous Areas	PLAY-P-0120	Play Room	120	
Miscellaneous Areas	RECEPTION-P-0080	Reception Area - Seats 1 to 4	80	4
Miscellaneous Areas	RECEPTION-P-0120	Reception Area - Seats 5 to 7	120	7
Miscellaneous Areas	RECEPTION-P-0240	Reception Area - Seats 8 to 13	240	13
Miscellaneous Areas	RECEPTION-P-0320	Reception Area - Seats 14 to 21	320	21
Miscellaneous Areas	RECEPTION-P-0400	Reception Area - Seats 22 to 27	400	27
Miscellaneous Areas	RESOURCE-O-0120	Resource Area / Library	120	
Miscellaneous Areas	RESOURCE-P-0120	Resource Room / Library	120	
Miscellaneous Areas	SERVER-P-120	Server Room - Small	120	
Miscellaneous Areas	SERVER-P-240	Server Room - Medium	240	
Miscellaneous Areas	SERVER-P-360	Server Room - Large	360	
Miscellaneous Areas	STORAGE-P-0120	Storage Room	120 ¹	
Miscellaneous Areas	STORAGE-P-0240	Storage Room	240 ¹	
Specialty Areas	ARMORY-P-0060	Armory	60	
Specialty Areas	COMP-P-0120	Computer / Testing	120	
Specialty Areas	DARK-P-0060	Dark Room	60	
Specialty Areas	DAYCARE-P-0120	Daycare Room	120	
Specialty Areas	DINING-P-0480	Dining Room	480	
Specialty Areas	DORM-P-0100	Dormitory (Sleeping Quarters Only)	100 ³	
Specialty Areas	EVIDENCE LKR-0080	Evidence Locker Room	80	
Specialty Areas	EVIDENCE-P-0120	Evidence Room	120	
Specialty Areas	EXAM-P-0080	Exam Room	80	
Specialty Areas	EXAM-P-0120	Exam Room	120	
Specialty Areas	EXERCISE-P-0500	Exercise Room	500	
Specialty Areas	FEE-P-0240	Fee Room	240	
Specialty Areas	GARAGE-P-0840	Garage	840	
Specialty Areas	GRAPHICS-P-0120	Graphics Room	120	
Specialty Areas	GUARD-O-0096	Guard Station	96	
Specialty Areas	HOLDING-P-0120	Child Holding Area	120	
Specialty Areas	IMAGING-P-0240	Imaging/File Room	240	
Specialty Areas	LAB-P-0200	Laboratory	200	
Specialty Areas	LAUNDRY-P-0100	Laundry	100	
Specialty Areas	LAYOUT-O-0036	Layout Area - Small	36	
Specialty Areas	LAYOUT-O-0064	Layout Area - Medium	64	
Specialty Areas	LAYOUT-O-0096	Layout Area - Large	96	
Specialty Areas	LOADDOCK-P-0300	Loading Dock - 1 Bay ²	300	
Specialty Areas	LOBBY-P-0100	Building / Floor Lobby Area	100	
Specialty Areas	MAINT-P-0150	Maintenance Shop	150	
Specialty Areas	MECH-P-0150	Mechanical Room	150	
Specialty Areas	PRINT-P-1000	Print Shop	1,000	

FUNCTIONAL TYPE	ROOM STANDARD	STANDARD DESCRIPTION	ALLOCATED AREA	CAPACITY
Specialty Areas	SHIP REC-P-0200	Shipping / Receiving	200	
Specialty Areas	URINALYSIS-P-0060	Urinalysis Room	60	
Specialty Areas	THERAPY-P-0120	Therapy Room	120	
Specialty Areas	WAREHOUSE-P-0500	Warehouse	500 ¹	
Staffing	OFFICE-P-0120	Office - 120 Square Feet	120	
Staffing	OFFICE-P-0240	Office - 240 Square Feet	240	
Staffing	WKSTN-O-0036	Workstation - 36 Square Feet	36	
Staffing	WKSTN-O-0048	Workstation - 48 Square Feet	48	
Staffing	WKSTN-O-0064	Workstation - 64 Square Feet	64	
Staffing	WKSTN-O-0096	Workstation - 96 Square Feet	96	
Staffing	WKSTN-O-0120	Workstation - 120 Square Feet	120	

¹ Written justification is needed if requiring a additional square footage.

² Written justification is needed if requiring a loading dock.

³ 100 sf per person. Indicate # of occupants needed.

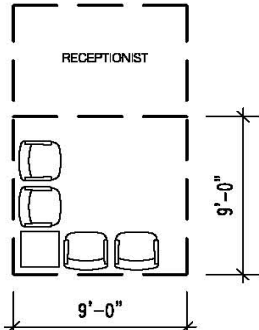

RECEPTION-P-0080
 1-4 SEATING CAPACITY
 80 SF

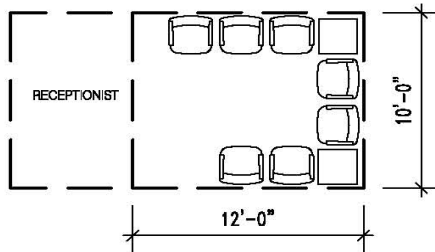

RECEPTION-P-0120
 5-7 SEATING CAPACITY
 120 SF

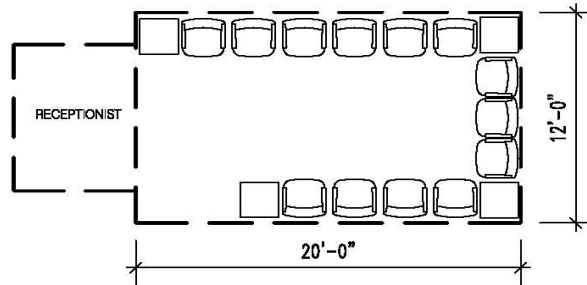

RECEPTION-P-0240
 8-13 SEATING CAPACITY
 240 SF

***NOTE:** THE SQUARE FOOTAGE DOES NOT INCLUDE RECEPTIONIST AREA.

STATE OF MISSOURI
 STATEWIDE SPACE STANDARDS

SUPPORT SPACE
RECEPTION TYPICALS
03-24-06

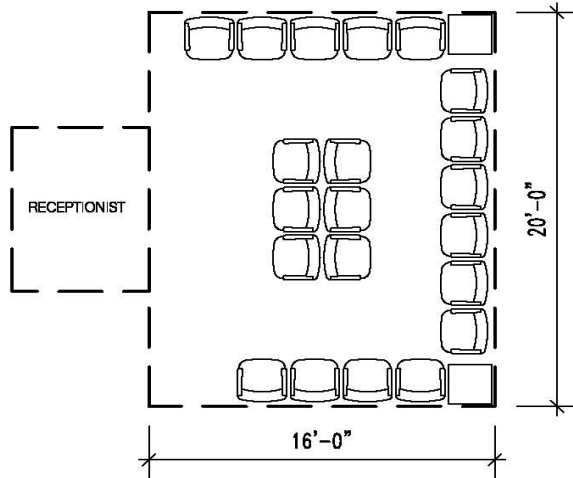

RECEPTION-P-0320
 14-21 SEATING CAPACITY
 320 SF

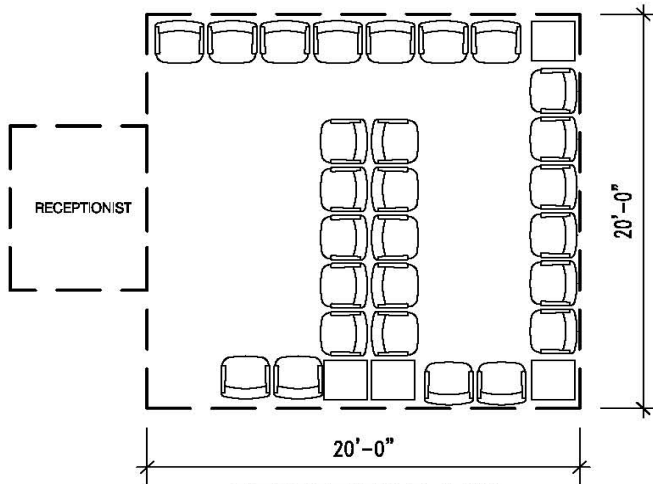

RECEPTION-P-0400
 22-27 SEATING CAPACITY
 400 SF

STATE OF MISSOURI
 STATEWIDE SPACE STANDARDS

SUPPORT SPACE
 RECEPTION TYPICALS
 03-24-06

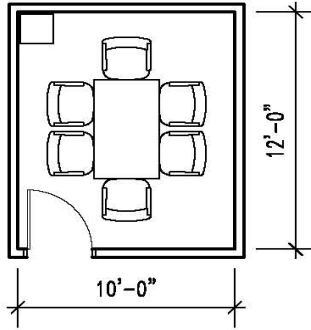

CONF-P-0120
 4-6 SEATING CAPACITY
 120 SF

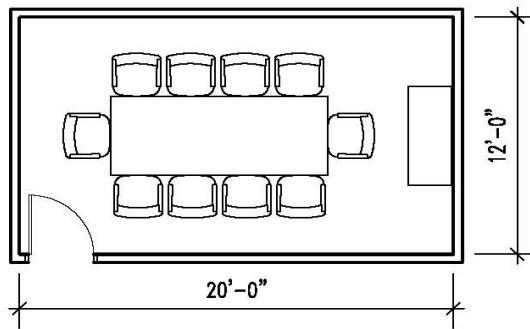

CONF-P-0240
 7-10 SEATING CAPACITY
 240 SF

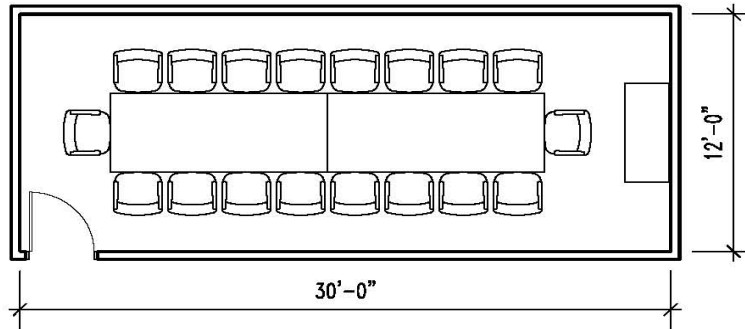

CONF-P-0360
 11-18 SEATING CAPACITY
 360 SF

STATE OF MISSOURI
 STATEWIDE SPACE STANDARDS

SUPPORT SPACE

CONFERENCE TYPICALS

03-24-06

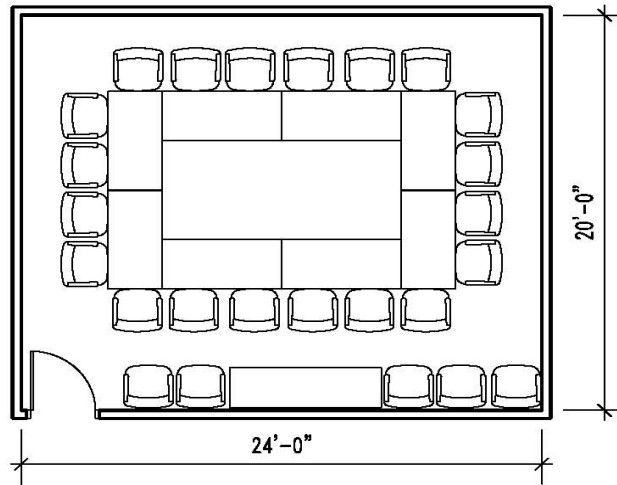

CONF-P-0480
 19-25 SEATING CAPACITY
 480 SF

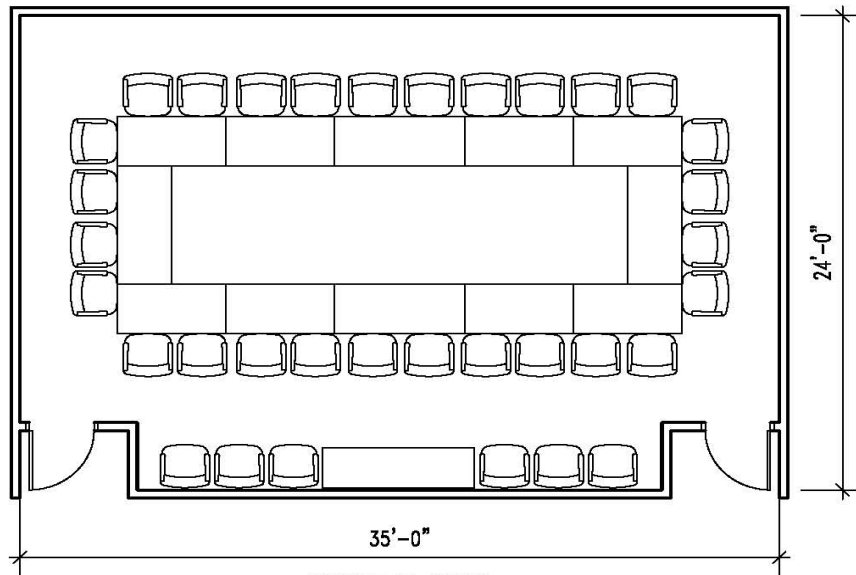

CONF-P-0840
 26-34 SEATING CAPACITY
 840 SF

STATE OF MISSOURI
 STATEWIDE SPACE STANDARDS

SUPPORT SPACE

CONFERENCE TYPICALS

03-24-06

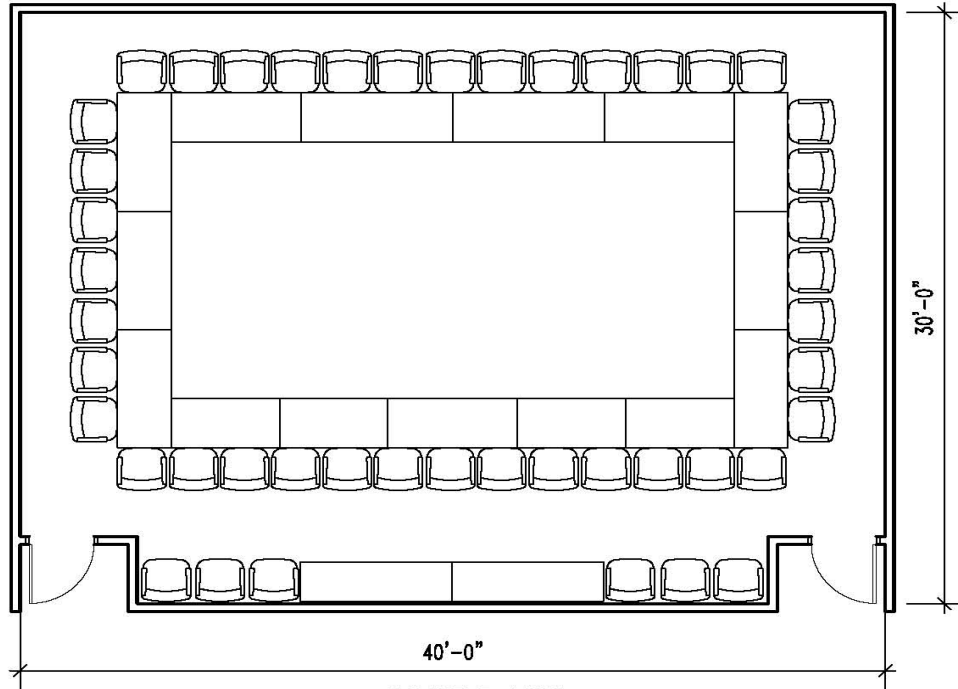

CONF-P-1200
 35-46 SEATING CAPACITY
 1200 SF

STATE OF MISSOURI
 STATEWIDE SPACE STANDARDS

SUPPORT SPACE
CONFERENCE TYPICALS
03-24-06

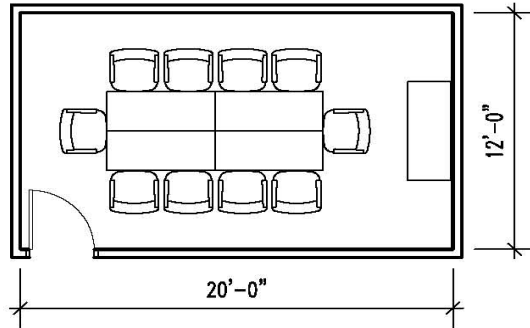

TRAINING-P-0240
 8-10 SEATING CAPACITY
 240 SF

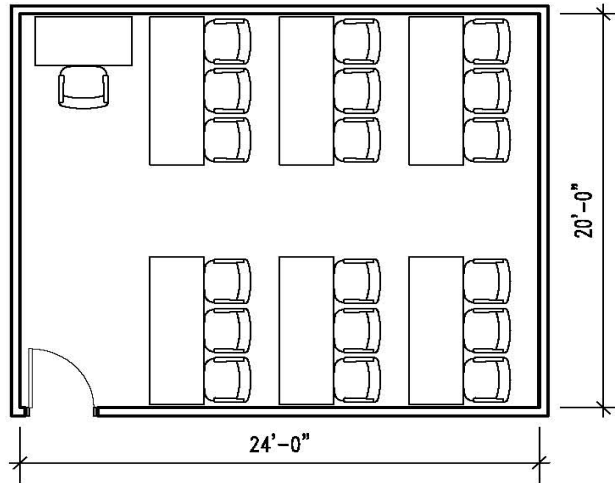

TRAINING-P-0480
 11-19 SEATING CAPACITY
 480 SF

STATE OF MISSOURI
 STATEWIDE SPACE STANDARDS

SUPPORT SPACE
 TRAINING TYPICALS
 03-24-06

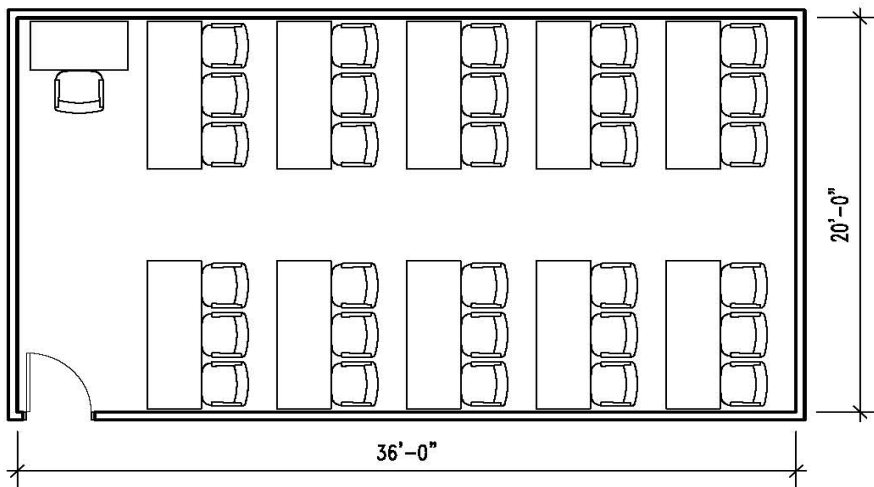

TRAINING-P-0720
 20-31 SEATING CAPACITY
 720 SF

STATE OF MISSOURI
 STATEWIDE SPACE STANDARDS

SUPPORT SPACE
TRAINING TYPICALS
03-24-06

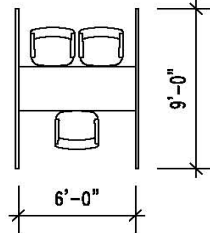

INTERVIEW-O-0054
 2-3 PERSON SEATING CAPACITY
 54 SF

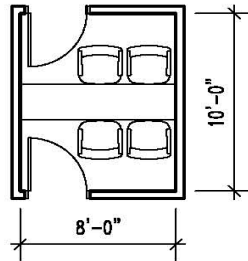

INTERVIEW-P-0080
 INTERVIEW ROOM
 4 PERSON SEATING CAPACITY
 80 SF

RATIO:
 PROBATION & PAROLE: 10 OFFICERS TO 1 INTERVIEW ROOM
 SOCIAL SERVICES: 10 CASE WORKERS TO 1 INTERVIEW ROOM

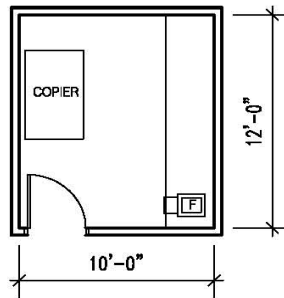

MAIL-P-0120
 MAIL/COPY ROOM
 120 SF

STATE OF MISSOURI
 STATEWIDE SPACE STANDARDS

SUPPORT SPACE

INTERVIEW/MAIL TYPICALS

03-24-06

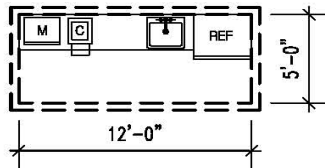

COFFEE-O-0060
 COFFEE BAR
 60 SF

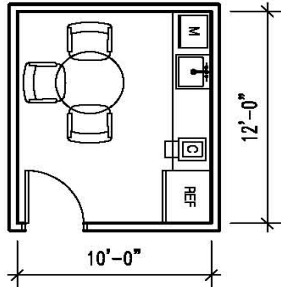

BREAK-P-0120
 1-3 SEATING CAPACITY
 120 SF
 FOR FACILITIES WITH 1 - 20 PEOPLE

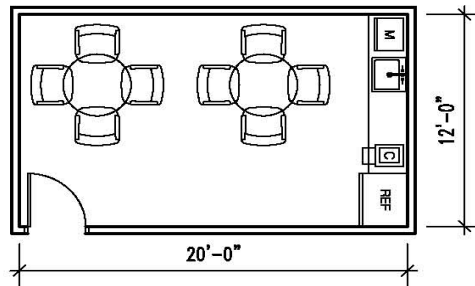

BREAK-P-0240
 4-8 SEATING CAPACITY
 240 SF
 FOR FACILITIES WITH 21 - 50 PEOPLE

TO DETERMINE THE SQUARE FOOTAGE OF BREAKROOMS IN FACILITIES WITH GREATER THAN 50 OCCUPANTS, CALCULATE THE FOLLOWING:
 (TOTAL # OF FTE X 25%) X 20 = SQUARE FOOTAGE OF BREAKROOM
 (ACTUAL SQUARE FOOTAGE MAY VARY BASED ON EXISTING FACILITIES. FINAL SQUARE FOOTAGE TO BE CONFIRMED BY FMDC.)

IF A BUILDING-WIDE CAFETERIA OR BREAKROOM IS AVAILABLE WITHIN A FACILITY, ONLY A COFFEE BAR IS PROVIDED WITHIN DIVISION SPACE.

STATE OF MISSOURI
 STATEWIDE SPACE STANDARDS

SUPPORT SPACE
 BREAKROOM TYPICALS
 04-20-06

Functional Support Areas Space Standards

Interview Booth/Room

INTERVIEW-O-0054	Interview Booth - 2 to 3 Person Capacity	54 sq ft
INTERVIEW-P-0080	4 Person Capacity	80 sq ft

Conference Room/Auditorium

Conference/Training Room sizes will be determined using the following data:

To determine total square footage allotment, calculate 85% of total # FTE. This will give you the area allotted for a division. For example, a 100 FTE group, $100 \times 85\% = 85$. Per the chart below, 85 equals 1,200 square feet. It is to the division's discretion to determine the breakdown of this total square footage allocation. This could be one 1,200 square foot conference room or five 240 square foot conference rooms, etc. If 85% of your total FTE is greater than 100 people, calculate the total allotment by the following example: 175 FTE's would equal $175 \times 85\% = 149$ people. The total square footage allotted for 149 people would be 1,200 sq ft plus 480 sq ft = 1,680 square feet. It would then be up to the division to determine the breakdown of conference rooms per the square footage allocation.

Conference Room Area Allotment

120 sq ft	4-6 People
240 sq ft	7-10 People
360 sq ft	11-23 People
480 sq ft	24-50 People
840 sq ft	51-75 People
1,200 sq ft	76-100 People

Written justification is needed for facilities requiring the following spaces:

Conference Room

CONF-P-1665	1,665 sq ft	(Seats 47–84)
CONF-P-3000	3,000 sq ft	(Seats 85–150)

Auditorium

AUD-P-02500	2,500 sq ft	Small (Seats 175–350)
AUD-P-06000	6,000 sq ft	Medium (Seats 351–800)
AUD-P-11500	11,500 sq ft	Large (Seats 801–1,600)

Circulation Factor

Consolidated Facilities shall include the following Circulation Factors in the Calculations:

30% - Total Departmental Circulation (inclusive of Staffing and Functional Support Area Square Footages)

Data/Telecommunications Room

Data/Telecommunication Rooms shall be calculated with the following formula:

Under	5,000 sq ft	64 sq ft
Under	10,000 sq ft	80 sq ft

For every additional 10,000 sq ft, a 100 sq ft data/telecommunications allocation will be provided.

Parking Lot Requirements

Parking is figured with the following formula:

Total #FTE + 25%

The average number of people occupying a facility on a given day is 75% of all FTE. The additional parking provided would account for clients visiting the building. In the event that there is a much larger client load expected, a 40% mark-up would be used in place of 25%. Written justification from the division would be needed before doing such.

Handicapped Parking

Total Parking in Lot	Required Minimum Number of Accessible Spaces
1 to 25	1
26 to 50	2
51 to 75	3
76 to 100	4
101 to 150	5
151 to 200	6
201 to 300	7
301 to 400	8
401 to 500	9
501 to 1,000	2 percent of total
1,001 and over	20, plus 1 for each 100 over 1,000

***One in every eight accessible spaces, but not less than one, shall be served by an access aisle 96" wide and be designated "van accessible".**

Restroom Requirements

Employee Restrooms

	<u># of Each Sex</u>	<u># of Closets</u>	<u># of Lavatories</u>	<u>Square Feet</u>
<u>Female</u>				
RESTROOM-F-0060	1-15	1	1	60
RESTROOM-F-0150	16-40	2	1	150
RESTROOM-F-0180	41-50	3	2	180
RESTROOM-F-0220	51-75	4	2	220
RESTROOM-F-0260	76-100	5	3	260
RESTROOM-F-0300	101-150	6	3	300
<u>Male</u>				
RESTROOM-M-0060	1-40	1	1	60
RESTROOM-M-0150	41-60	2	1	150
RESTROOM-M-0180	61-100	3	2	180
RESTROOM-M-0220	101-150	4	2	220
<u>Unisex</u>				
RESTROOM-U-0060	1-15 (RE: Note #3)	1	1	60

- NOTES:
- The formula to calculate restroom requirements is as follows: Net Gross Sq Ft ÷ 100 = X. Then X ÷ 2 = Y, with Y equaling the number of each sex. For example, a 10,000 sq ft facility = 10,000 ÷ 100 = 100: 100 ÷ 2 = 50. Per the above chart, fifty females equal 3 closets/2 lavatories/180 sq ft and fifty males equal 2 closets/1 lavatory/150 sq ft.
 - Over 150 add one fixture for each additional 80 males and one fixture for each additional 40 females. Lavatories should always to be one-half the number of water closets (round up).
 - Where plumbing fixtures are required, separate facilities shall be provided for each sex, with the exceptions of the following:
 - Separate employee facilities shall not be required in occupancies in which 15 or fewer people are employed.
 - Separate facilities shall not be required in structures or tenant spaces with a total occupant load, including both employees and customers, of 15 or less.

Client Restrooms

	<u># of Closets</u>	<u># of Lavatories</u>	<u>Square Feet</u>
<u>Unisex</u>			
RESTROOM-CU-0060	1	1	60
<u>Female</u>			
RESTROOM-CF-0060	1	1	60
<u>Male</u>			
RESTROOM-CM-0060	1	1	60

NOTE: One unisex client restroom can be provided if total visitor occupancy is less than 15.

E. SAMPLE SPACE ANALYSIS *(Under Development)*

In this section will be a sample Space Analysis, which each division will electronically complete via the FMDC website. This is currently under development. FMDC will send out notification when this portion of the Space Standards is complete.

Until further notice, please request space through the Facility Request Form and the Office and Workstation Requirement Form. Both of these are available on our website <http://www.oa.mo.gov/fmdc/> under the **State Agency Information** section, along with the current Statewide Space Standards Manual. The requesting division should determine the required space through the use of this procedure and the State of Missouri Space Standards shown in this manual. They will prepare a list of the approved personnel who will occupy the space, along with functional support requirements. Any unusual circumstances which go beyond the guidelines must be identified and complete justification provided. The FMDC (Facilities Management and Design and Construction) group of the State of Missouri will then assist divisions in designing the requested office layout.

UNDER DEVELOPMENT

SECTION F – SPACE STANDARD APPEALS PROCESS

The Space Standards contained in this document are intended to provide guidance and uniformity to the space planning process for State of Missouri employees. The Division of Facilities Management, Design and Construction (FDDC) will strive to apply these standards in a fair and equitable manner.

The Director of Planning for FMDC will review and approve all space analysis prior to issuance to the requesting department and ensure that, as closely as possible, such space analyses conform to the Space Standards. Because each space planning issue is unique, disagreements regarding decisions made by FMDC will inevitably be a part of the process from time to time. In recognition of this fact, an appeals process has been established such that, when there is disagreement with the FMDC Director of Planning, agencies may appeal such decisions to the Director of FMDC.

Appeals to the Director of FMDC shall be made in writing by the requesting Department Director or their designated representative. In the event that the appeal is denied by the Director of FMDC, departments may appeal directly to the Commissioner of the Office of Administration. Appeals to the Commissioner shall be made in writing by the requesting Department Director or their designated representative. All decisions regarding appeals by the Commissioner shall be made in writing to the requesting department representative and shall be final.